

PRODUCT DATASHEET

PL PFM 625 DALI 36 W 4000 K UGR19

PANEL PERFORMANCE 625 UGR<19 DALI | Square recessed panel luminaires, tool-free installation and low glare, for 625 x 625 mm ceiling systems with DALI-2 IoT technology



Areas of application

- Direct replacement for luminaires with fluorescent lamps
- Offices, conference rooms
- Reception areas, foyers, corridors, elevators
- Suitable for recessed ceiling systems with grid size of 625 x 625 mm

Product benefits

- Suitable luminaire for VIVARES and other DALI-2 Light Management Systems
- Tool-free electrical connection due to push button connector
- Through-wiring possible with included connector box
- Energy savings thanks to high system efficacy: up to 120 lm/W
- Good glare reduction (UGR < 19)
- Comfortable light and high color consistency
- External driver for extended flexibility and easy installation
- Low flicker light thanks to special electronic control gear
- 5 years guarantee

Product features

- IoT-ready luminaire with DALI-2 technology
- Extruded aluminum frame
- Polystyrene diffuser



- 3-pole terminal block, cable cross section up to $3 \times 2.5 \text{ mm}^2$ (25 W and 30 W versions)
- 5-pole terminal block, cable cross section up to $5 \times 2.5 \text{ mm}^2$ (36 W versions and DALI types)
- Lifetime (L80/B10): up to 60,000 h (at 25 °C)

TECHNICAL DATA

Electrical data

| | |
|-------------------------------------------------------------|---------------------|
| Nominal wattage | 36.00 W |
| Nominal voltage | 220...240 V |
| Mains frequency | 0/50/60 Hz |
| Nominal current | 160 mA |
| Inrush current | 30 A |
| Inrush current time T_{h50} | 200 μ s |
| Max. number of luminaires per miniature circuit breaker B16 | 20 |
| Max. number of luminaires per miniature circuit breaker C10 | 21 |
| Max. number of luminaires per miniature circuit breaker C16 | 33 |
| Power factor λ | > 0.95 |
| Total harmonic distortion | < 10 % |
| Protection class | II |
| Operating mode | External LED driver |
| Dimming interface | DALI-2/loT |

Photometrical data

| | |
|----------------------------------------------|--------------------|
| Luminous flux | 4320 lm |
| Luminous efficacy | 120 lm/W |
| Color temperature | 4000 K |
| Light color (designation) | Cool White |
| Color rendering index Ra | > 80 |
| Standard deviation of color matching | 3 sdc _m |
| Luminous intensity | - |
| Low flicker | Yes |
| Flickering metric (Pst LM) | - |
| Stroboscope effect metric (SVM) | - |
| Photobiological safety group acc. to EN62778 | RG0 |
| Photobiological safety group acc. to EN62471 | RG0 |
| Beam angle | 90 ° |
| UGR | < 19 |

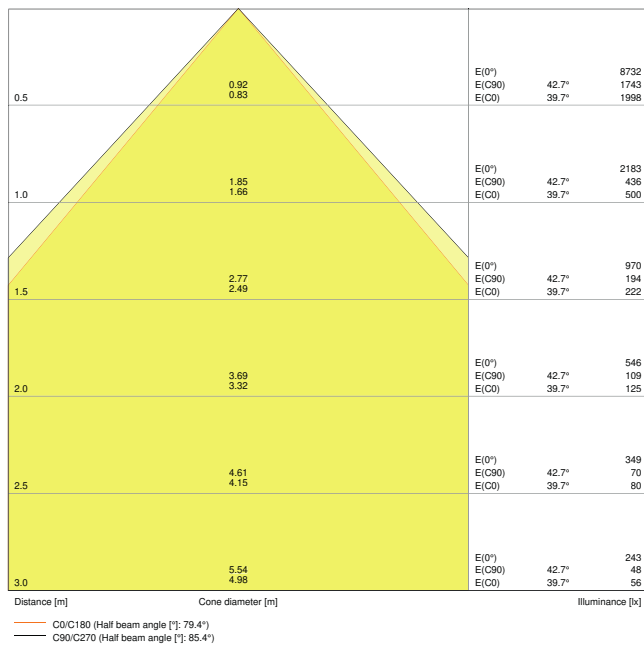

PL PFM 625 DALI 36W 4000K UGR19 LDT

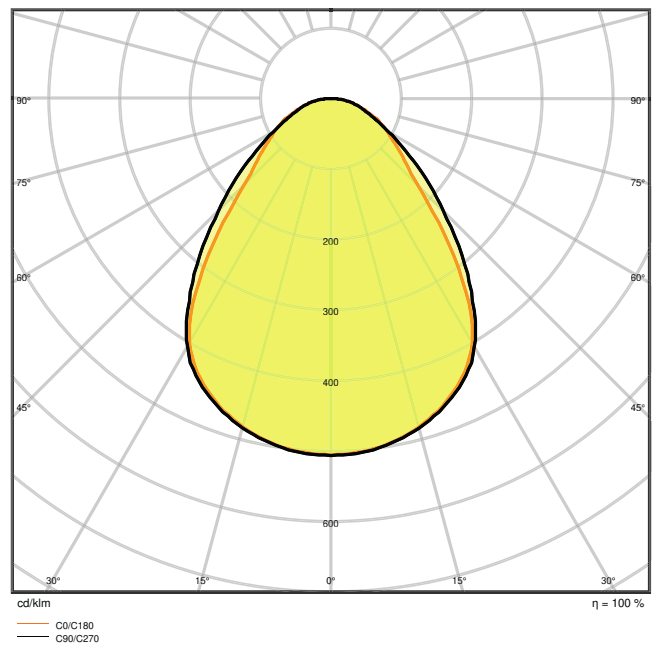

PL PFM 625 DALI 36W 4000K UGR19 LDT

Dimensions & Weight

| | |
|----------------|-----------|
| Length | 620.00 mm |
| Width | 620.00 mm |
| Height | 32.00 mm |
| Product weight | 2200.00 g |

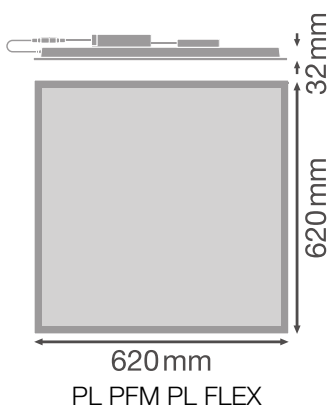

Materials & Colors

| | |
|--------------------------------------------|------------------|
| Product color | White |
| Housing color | White |
| Body material | Steel |
| Cover material | Polystyrene (PS) |
| Light emitting surface material | Polystyrene |
| Glow Wire Test according to IEC 60695-2-12 | 650 °C |
| Mercury content | 0.0 mg |

Application & Mounting

| | |
|----------------------------------------|-------------------------------------------------|
| Ambient temperature range | -10...+50 °C |
| Type of connection | Screwless terminal, 5-Pole (L, N, PE, DA+, DA-) |
| Type of protection | IP40/IP20 |
| Protection class IK (shock resistance) | IK02 |
| Dimmable | Yes |
| Type of dimming | DALI |
| Mounting type | Recessed/Suspended/Surface |
| Mounting location | Ceiling / Wall |
| Application environment | Indoor |
| Mounting length | 600,0 mm |
| Mounting width | 600,0 mm |
| Mounting depth | 80,0 mm |
| With light source | Yes |

Lifespan

| | |
|----------------------------|------------------------|
| Lifespan L70/B50 at 25 °C | 100000 h ¹⁾ |
| Lifespan L80/B10 at 25 °C | 60000 h ¹⁾ |
| Lifespan L80/B50 at 25 °C | 60000 h |
| Lifespan L90/B10 at 25 °C | 35000 h |
| Number of switching cycles | 50000 |

¹⁾ t[h]: L70 / B50 @ 25 °C (Ta), t[h]: L80 / B10 @ 25 °C (Ta), t[h]: L90 / B10 @ 25 °C (Ta)



Control gear

| | |
|-----------------------------|--------|
| Output current | 760 mA |
| ECG - Output ripple current | < 3 % |

Certificates & Standards

| | |
|------------------------------------------------------|----------------------|
| Standards | CE / CB / ENEC / EAC |
| Luminaire with limited surface temperature, "D sign" | No |
| Ball shot safe | No |
| Replaceable light source (EPREL) | Not replaceable |















Accessories Optional

| Product image | Product name | EAN |
|-------------------------------------------------------------------------------------|-------------------------------------|---------------|
|  | PANEL Suspension Kit | 4058075402928 |
|  | PANEL 625 RECESSED MOUNT FRAME | 4058075402904 |
|  | PANEL 625 SURFACE MOUNT KIT H75 | 4058075472938 |
|  | PANEL 625 SURFACE MOUNT KIT H70 VAL | 4058075402867 |
|  | PANEL SECURITY KIT 4x | 4058075472990 |
|  | PANEL RECESSED MOUNT CLIPS VAL 4x | 4058075409859 |

EQUIPMENT / ACCESSORIES

- Accessories for several mounting options available
- Connector box with 3-pole or 5-pole terminal included
- Security brackets included
- External control gear included
- Not suitable for use with Emergency Conversion Box

DOWNLOAD DATA

| Documents and certificates | | Document name |
|------------------------------------------------------------------------------------|----------------------------------------|-------------------------------------------------------|
|  | User instruction / safety instructions | PANEL PERFORMANCE 600/625 DALI |
|  | Legal information | Legal insert |
|  | Legal information | LSI PL PFM AND PL PFM DALI |
|  | Legal information | LSI PL PFM AND PL PFM DALI |
|  | Declarations of conformity | PL PFM 600 DALI 36W |
| Photometric and lighting design files | | Document name |
|  | IES file (IES) | PL PFM 625 DALI 36W 4000K UGR19 |
|  | LDT file (Eulumdat) | PL PFM 625 DALI 36W 4000K UGR19 LDT |
|  | ULD file (DIALux) | PL PFM 625 DALI 36W-4000K |
|  | ROLF file (RELUX) | PL PFM 35 DALI |
|  | UGR file (UGR table) | PL PFM 625 DALI 36W 4000K UGR19 LDT |
|  | Light distribution curve type cone | PL PFM 625 DALI 36W 4000K UGR19 LDT |
|  | Light distribution curve type polar | PL PFM 625 DALI 36W 4000K UGR19 LDT |
| CAD/BIM files | | Document name |
|  | BIM Revit 3D | PL PFM gen3 |
|  | CAD STEP 3D | PL PFM gen3 625 |
| Tender texts | | Document name |
|  | Tender documents | PANEL PERFORMANCE 625 UGR19 DALI 36 W 4000 K UGR19-EN |

LOGISTICAL DATA

| Product code | Packaging unit (Pieces/Unit) | Dimensions (length x width x height) | Gross weight | Volume |
|---------------|------------------------------|--------------------------------------|--------------|------------------------|
| 4058075440777 | Folding box 1 | 52 mm x 647 mm x 719 mm | 2720.00 g | 24.19 dm ³ |
| 4058075440784 | Shipping box 4 | 665 mm x 220 mm x 735 mm | 12248.00 g | 107.53 dm ³ |

The mentioned product code describes the smallest quantity unit which can be ordered. One shipping unit can contain one or more single products. When placing an order, for the quantity please enter single or multiples of a shipping unit.

ADDITIONAL CATALOG INFORMATION

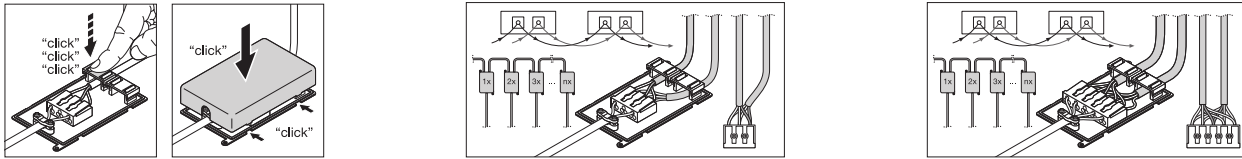

References / Links

– For Guarantee see www.ledvance.com/guarantee

DISCLAIMER

Subject to change without notice. Errors and omission excepted. Always make sure to use the most recent release.