

PRODUCT DATASHEET

FL PFM DA ASYM 45X140 100W 4000K BK

FLOODLIGHT PERFORMANCE DALI ASYM 45x140 | DALI 2.0 based floodlight with very wide beam, asymmetric light distribution for area lighting



Areas of application

- Direct replacement for luminaires using HID lamps
- Outdoor use (IP66)
- Parking
- Public areas
- Industry
- Sports facilities
- Parking lots, industrial roads
- D-sign according to EN 60598-2-24 for fire-risk commercial unit, e.g. by accumulation of dust

Product benefits

- Energy savings of up to 90 % compared to halogen lamp floodlights
- Energy savings of up to 45 % compared to luminaires that use conventional discharge lamps
- Bright, robust and durable
- Homogeneous luminance distribution and reduced glare
- No upper light output ratio (ULOR 0%) when mounted at 0° tilt
- Key hole to ensure ease of installation
- 5 years guarantee

Product features

- DALI 2.0 interface for light management system integration
- High luminous efficacy: up to 140 lm/W
- Asymmetric light distribution for area lighting
- Angled (45°) mounting bracket and up to 180° tilting
- High surge protection: up to 10 kV (L/N-PE), 6 kV (L-N)



- Integrated breather for preventing condensation inside the luminaire
- Connection via 2 m cable, wiring required
- Type of protection: IP66
- Impact resistance: IK08
- Ambient temperature in operation: -30...+50 °C

TECHNICAL DATA

Electrical data

Nominal wattage	100.00 W
Nominal voltage	220...240 V
Mains frequency	50...60 Hz
Nominal current	490.000 mA
Inrush current	180 A
Inrush current time T_{h50}	150 μ s
Max. number of luminaires per miniature circuit breaker B16	5
Max. number of luminaires per miniature circuit breaker C10	5
Max. number of luminaires per miniature circuit breaker C16	8
Power factor λ	> 0.90
Total harmonic distortion	< 10 %
Protection class	I
Operating mode	Integrated LED driver
Dimming interface	DALI-2

Photometrical data

Luminous flux	12800 lm
Luminous efficacy	128 lm/W
Color temperature	4000 K
Light color (designation)	Cool White
Color rendering index Ra	> 80
Standard deviation of color matching	\leq 5 sdc _m
Low flicker	Yes
Photobiological safety group acc. to EN62778	RG1
Photobiological safety group acc. to EN62471	RG1
Beam angle	45 ° x 140 °

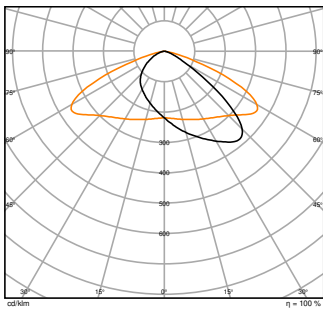

FL PFM DA 100W 4000K ASYM
45X140 BK

Dimensions & Weight

Length	418.00 mm
Width	330.00 mm
Height	77.00 mm
Product weight	4300.00 g
Cable length	2000 mm

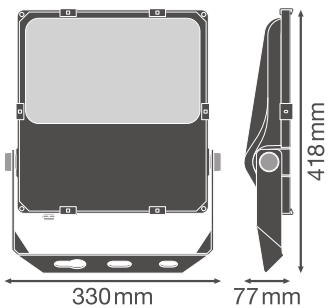

FL PFM 100W ASYM

Materials & Colors

Product color	Black
Housing color	Black
Body material	Aluminum
Cover material	Glass
Light emitting surface material	Glass
Glow Wire Test according to IEC 60695-2-12	650 °C

Mercury content	0.0 mg
-----------------	--------

Application & Mounting

Ambient temperature range	-30...+50 °C
Temperature range at storage	-40...+70 °C
Type of connection	Cable, 5-pole
Type of protection	IP66
Protection class IK (shock resistance)	IK08
Dimmable	Yes
Type of dimming	DALI
Mounting type	Surface
Mounting location	Wall / Pole / Floor / Ceiling
Application environment	Outdoor
Adjustable	Yes
With light source	Yes

Lifespan

Lifespan L70/B50 at 25 °C	100000 h ¹⁾
Lifespan L80/B10 at 25 °C	70000 h ¹⁾
Lifespan L80/B50 at 25 °C	70000 h
Lifespan L90/B10 at 25 °C	30000 h
Number of switching cycles	100000

¹⁾ t[h]: L70 / B50 @ 25 °C (Ta), t[h]: L80 / B10 @ 25 °C (Ta), t[h]: L90 / B10 @ 25 °C (Ta)

















Control gear

ECG - Output ripple current	< 10 %
-----------------------------	--------

Certificates & Standards

Standards	CE / CB / ENEC / TÜV SÜD / UKCA / EAC
Luminaire with limited surface temperature, "D sign"	Yes
Ball shot safe	No
Replaceable light source (EPREL)	Not replaceable

DOWNLOAD DATA

Documents and certificates		Document name
	User instruction / safety instructions	FLOODLIGHT PERFORMANCE DALI
	Legal information	LSI Floodlight PFM DALI
	Legal information	Legal Insert FL PFM DA
	Legal information	Informationstext 18 Abs 4 ElektroG
	Declarations of conformity	CE Declaration of Conformity FLOODLIGHT PFM DA BK
	Declarations of conformity UKCA	UKCA Declaration of Conformity FLOODLIGHT PFM DA BK
	Declarations of conformity UKCA	FL PFM DA BK
	Certificates	FL PFM DA
Photometric and lighting design files		Document name
	IES file (IES)	FL PFM DA 100W 4000K ASYM 45X140 BK
	LDT file (Eulumdat)	FL PFM DA 100W 4000K ASYM 45X140 BK
	ULD file (DIALux)	FL PFM DA 100W 4000K ASYM
	ROLF file (RELUX)	FL PFM DA 100W 4000K ASYM
	Light distribution curve type polar	FL PFM DA 100W 4000K ASYM 45X140 BK
CAD/BIM files		Document name
	BIM Revit 3D	FL PFM
	CAD STEP 3D	FL PFM 100W
Tender texts		Document name
	Tender documents	FLOODLIGHT PERFORMANCE DALI ASYM 45x140 100W 4000K BK-EN

LOGISTICAL DATA

Product code	Packaging unit (Pieces/Unit)	Dimensions (length x width x height)	Gross weight	Volume
4058075760653	Shipping box 1	474 mm x 120 mm x 368 mm	4325.00 g	20.93 dm ³

The mentioned product code describes the smallest quantity unit which can be ordered. One shipping unit can contain one or more single products. When placing an order, for the quantity please enter single or multiples of a shipping unit.

ADDITIONAL CATALOG INFORMATION

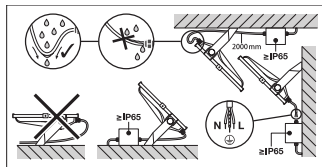
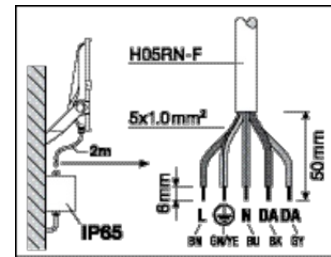
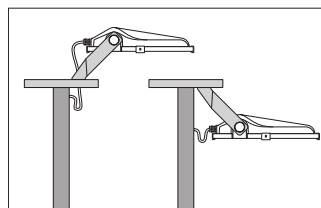
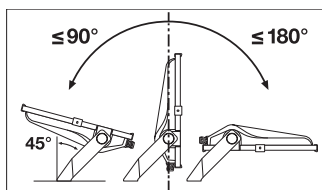

References / Links

– For Guarantee see www.ledvance.com/guarantee

DISCLAIMER

Subject to change without notice. Errors and omission excepted. Always make sure to use the most recent release.