

# PRODUCT DATASHEET

## FL PFM DA SYM 60 290W 4000K BK

FLOODLIGHT PERFORMANCE DALI SYM 60 | DALI 2.0 based floodlight with symmetric light distribution for medium to high mast area lighting



### Areas of application

- Direct replacement for luminaires using HID lamps
- Outdoor use (IP66)
- Parking
- Public areas
- Industry
- Sports facilities
- Lighting of large areas
- D-sign according to EN 60598-2-24 for fire-risk commercial unit, e.g. by accumulation of dust

### Product benefits

- Energy savings of up to 90 % compared to halogen lamp floodlights
- Energy savings of up to 45 % compared to luminaires that use conventional discharge lamps
- Bright, robust and durable
- Homogeneous luminance distribution and reduced glare
- No upper light output ratio (ULOR 0%) when mounted at 0° tilt
- Key hole to ensure ease of installation
- 5 years guarantee

### Product features

- DALI 2.0 interface for light management system integration
- High luminous efficacy: up to 140 lm/W
- Symmetric light distribution for medium to high mast area lighting
- Angled (45°) mounting bracket and up to 180° tilting
- High surge protection: up to 10 kV (L/N-PE), 6 kV (L-N)



- Integrated breather for preventing condensation inside the luminaire
- Connection via 2 m cable, wiring required
- Type of protection: IP66
- Impact resistance: IK08
- Ambient temperature in operation: -30...+50 °C

## TECHNICAL DATA

### Electrical data

|   |                       |
|---|-----------------------|
| Nominal wattage   | 290.00 W              |
| Nominal voltage   | 220...240 V           |
| Mains frequency   | 50...60 Hz            |
| Nominal current   | 1420.000 mA           |
| Inrush current  | 110 A                 |
| Inrush current time $T_{h50}$                               | 500 $\mu$ s           |
| Max. number of luminaires per miniature circuit breaker B16 | 2                     |
| Max. number of luminaires per miniature circuit breaker C10 | 2                     |
| Max. number of luminaires per miniature circuit breaker C16 | 3                     |
| Power factor $\lambda$                                      | > 0.90                |
| Total harmonic distortion                                   | < 10 %                |
| Protection class  | I                     |
| Operating mode  | Integrated LED driver |
| Dimming interface   | DALI-2                |

### Photometrical data

|  |                           |
|--|---------------------------|
| Luminous flux                                | 40600 lm                  |
| Luminous efficacy                            | 140 lm/W                  |
| Color temperature                            | 4000 K                    |
| Light color (designation)                    | Cool White                |
| Color rendering index Ra                     | > 80                      |
| Standard deviation of color matching         | $\leq$ 5 sdc <sub>m</sub> |
| Low flicker                                  | Yes                       |
| Photobiological safety group acc. to EN62778 | RG1                       |
| Photobiological safety group acc. to EN62471 | RG1                       |
| Beam angle                                   | 60 ° x 60 °               |

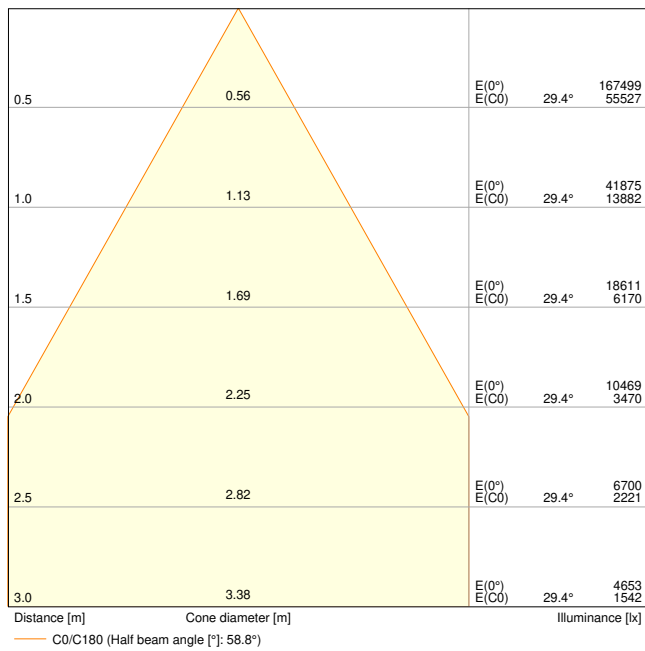

FL PFM DA 290W 4000K SYM 60 BK

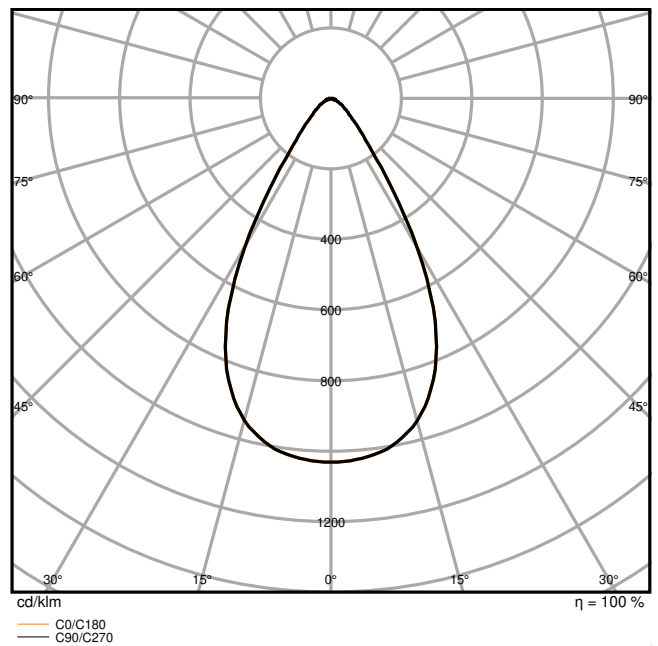

FL PFM DA 290W 4000K SYM 60 BK

### Dimensions & Weight

|                |           |
|----------------|-----------|
| Length         | 567.00 mm |
| Width          | 465.00 mm |
| Height         | 97.00 mm  |
| Product weight | 9300.00 g |
| Cable length   | 2000 mm   |

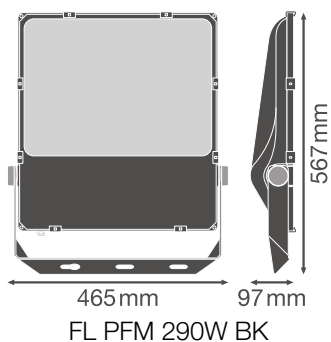

### Materials & Colors

|  |          |
|--|----------|
| Product color                              | Black    |
| Housing color                              | Black    |
| Body material                              | Aluminum |
| Cover material                             | Glass    |
| Light emitting surface material            | Glass    |
| Glow Wire Test according to IEC 60695-2-12 | 650 °C   |
| Mercury content                            | 0.0 mg   |

### Application & Mounting

|  |                               |
|--|-------------------------------|
| Ambient temperature range              | -30...+50 °C                  |
| Temperature range at storage           | -40...+70 °C                  |
| Type of connection                     | Cable, 5-pole                 |
| Type of protection                     | IP66                          |
| Protection class IK (shock resistance) | IK08                          |
| Dimmable                               | Yes                           |
| Type of dimming                        | DALI                          |
| Mounting type                          | Surface                       |
| Mounting location                      | Wall / Pole / Floor / Ceiling |
| Application environment                | Outdoor                       |
| Adjustable                             | Yes                           |
| With light source                      | Yes                           |

### Lifespan

|                            |                        |
|----------------------------|------------------------|
| Lifespan L70/B50 at 25 °C  | 100000 h <sup>1)</sup> |
| Lifespan L80/B10 at 25 °C  | 70000 h <sup>1)</sup>  |
| Lifespan L80/B50 at 25 °C  | 70000 h                |
| Lifespan L90/B10 at 25 °C  | 30000 h                |
| Number of switching cycles | 100000                 |

<sup>1)</sup> t[h]: L70 / B50 @ 25 °C (Ta), t[h]: L80 / B10 @ 25 °C (Ta), t[h]: L90 / B10 @ 25 °C (Ta)

### Control gear















|                             |        |
|-----------------------------|--------|
| ECG - Output ripple current | < 10 % |
|-----------------------------|--------|



### Certificates & Standards

|  |                                       |
|--|---------------------------------------|
| Standards  | CE / CB / ENEC / TÜV SÜD / UKCA / EAC |
| Luminaire with limited surface temperature, "D sign" | Yes                                   |

|                                  |                 |
|----------------------------------|-----------------|
| Ball shot safe                   | Yes             |
| Replaceable light source (EPREL) | Not replaceable |

## DOWNLOAD DATA

| Documents and certificates   |  | Document name                                       |
|--|--|---|
|    | User instruction / safety instructions | FLOODLIGHT PERFORMANCE DALI                         |
|    | Legal information                      | LSI Floodlight PFM DALI                             |
|    | Legal information                      | Legal Insert FL PFM DA                              |
|    | Legal information                      | Informationstext 18 Abs 4 ElektroG                  |
|    | Declarations of conformity             | CE Declaration of Conformity FLOODLIGHT PFM DA BK   |
|    | Declarations of conformity UKCA        | UKCA Declaration of Conformity FLOODLIGHT PFM DA BK |
|  | Declarations of conformity UKCA        | FL PFM DA BK  |
|  | Certificates                           | FL PFM DA   |
| Photometric and lighting design files  |  | Document name                                       |
|  | IES file (IES)                         | FL PFM DA 290W 4000K SYM 60 BK                      |
|  | LDT file (Eulumdat)                    | FL PFM DA 290W 4000K SYM 60 BK                      |
|  | ULD file (DIALux)                      | FL PFM DA 290W 4000K SYM                            |
|  | ROLF file (RELUX)                      | FL PFM DA 290W 4000K SYM                            |
|  | UGR file (UGR table)                   | FL PFM DA 290W 4000K SYM 60 BK                      |
|  | Light distribution curve type cone     | FL PFM DA 290W 4000K SYM 60 BK                      |
|  | Light distribution curve type polar    | FL PFM DA 290W 4000K SYM 60 BK                      |

| CAD/BIM files  |              | Document name |
|--|--------------|---------------|
|  | BIM Revit 3D | FL PFM        |
|  | CAD STEP 3D  | FL PFM 290W   |

| Tender texts   |                  | Document name                                       |
|--|------------------|---|
|  | Tender documents | FLOODLIGHT PERFORMANCE DALI SYM 60 290W 4000K BK-EN |

**LOGISTICAL DATA**

| Product code  | Packaging unit (Pieces/Unit) | Dimensions (length x width x height) | Gross weight | Volume                |
|---------------|------------------------------|--------------------------------------|--------------|-----------------------|
| 4058075760868 | Shipping box<br>1            | 652 mm x 160 mm x 510 mm             | 10258.00 g   | 53.20 dm <sup>3</sup> |

The mentioned product code describes the smallest quantity unit which can be ordered. One shipping unit can contain one or more single products. When placing an order, for the quantity please enter single or multiples of a shipping unit.

**ADDITIONAL CATALOG INFORMATION**

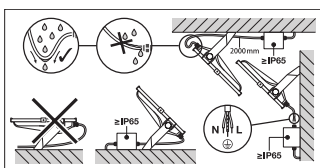
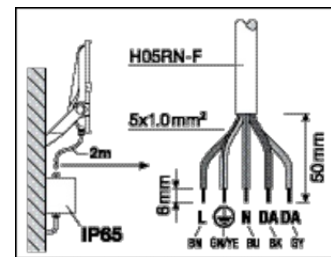
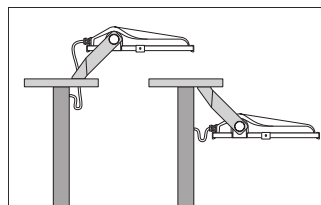
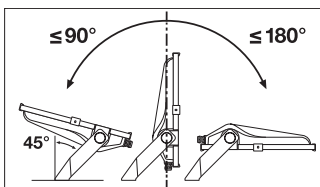

**References / Links**

– For Guarantee see [www.ledvance.com/guarantee](http://www.ledvance.com/guarantee)

**DISCLAIMER**

Subject to change without notice. Errors and omission excepted. Always make sure to use the most recent release.