

# PRODUCT DATASHEET

## PL COMP 625 V 33W 840 U19

PANEL COMPACT 625 UGR<19 | Square recessed panel luminaire with low glare, for 625 x 625 mm ceiling systems



### Areas of application

- Direct replacement for luminaires with fluorescent lamps
- Offices, conference rooms
- Reception areas, foyers, corridors, elevators
- Suitable for recessed ceiling systems with grid size of 625 x 625 mm

### Product benefits

- Good glare reduction (UGR < 19)
- Low flicker light thanks to special electronic control gear
- Energy savings thanks to system efficacy of up to 110 lm/W
- External driver with an optional 3-pole through-wiring feature
- Versions with DALI ECG available
- 5 years guarantee

### Product features

- Extruded aluminum frame
- Polystyrene diffuser
- Lifetime (L80/B10): up to 50,000 h (at 25 °C)



## TECHNICAL DATA

### Electrical data

Nominal wattage	33.00 W
Nominal voltage	220...240 V
Mains frequency	50...60 Hz
Nominal current	150.000 mA
Inrush current	1.7 A
Inrush current time $T_{h50}$	52 $\mu$ s
Max. number of luminaires per miniature circuit breaker B16	61
Max. number of luminaires per miniature circuit breaker C10	48
Max. number of luminaires per miniature circuit breaker C16	78
Power factor $\lambda$	> 0.90
Total harmonic distortion	< 10 %
Protection class	II
Operating mode	External LED driver

### Photometrical data

Luminous flux	3630 lm
Luminous efficacy	110 lm/W
Color temperature	4000 K
Light color (designation)	Cool White
Color rendering index Ra	> 80
Standard deviation of color matching	$\leq$ 5 sdc <sub>m</sub>
Low flicker	Yes
Flickering metric (Pst LM)	<1
Stroboscope effect metric (SVM)	< 0.4
Photobiological safety group acc. to EN62778	RG0
Beam angle	90 °
UGR	< 19

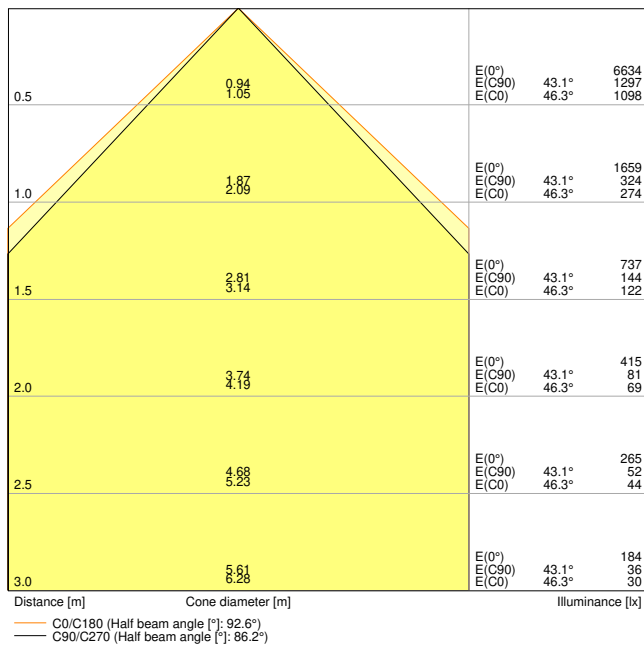

PL COMP 625 V 33W 840 U19 EM CONVERSION BOX

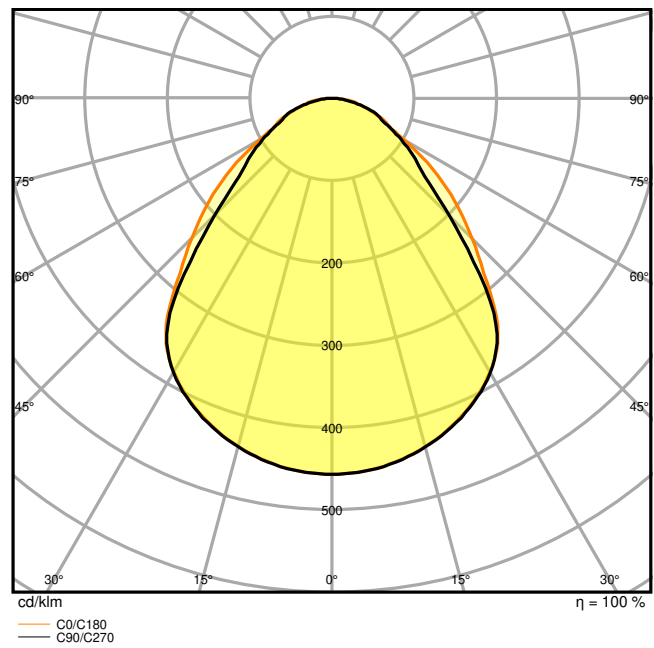

PL COMP 625 V 33W 840 U19 EM CONVERSION BOX

Dimensions & Weight

Length	620.00 mm
Width	620.00 mm
Height	32.00 mm
Product weight	1800.00 g

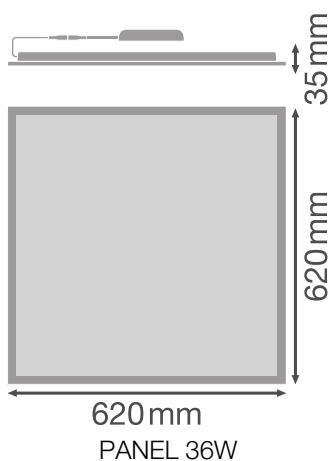

## Materials & Colors

Product color	White
Housing color	White
Body material	Aluminum
Cover material	Polystyrene (PS)
Light emitting surface material	Polystyrene
Glow Wire Test according to IEC 60695-2-12	650 °C
Mercury content	0.0 mg

## Application & Mounting

Ambient temperature range	-10...+45 °C
Temperature range at storage	-20...+70 °C
Type of connection	Screwless terminal, 2-Pole (L, N)
Type of protection	IP40/IP20
Protection class IK (shock resistance)	IK02
Dimmable	No
Mounting type	Recessed/Suspended/Surface
Mounting location	Ceiling
Application environment	Indoor
Mounting length	600,0 mm
Mounting width	600,0 mm
Mounting depth	50,0 mm
Adjustable	No
With light source	Yes

## Lifespan

Lifespan L70/B50 at 25 °C	70000 h <sup>1)</sup>
Lifespan L80/B10 at 25 °C	50000 h <sup>1)</sup>
Lifespan L80/B50 at 25 °C	50000 h
Lifespan L90/B10 at 25 °C	40000 h
Number of switching cycles	50000

<sup>1)</sup> t[h]: L70 / B50 @ 25 °C (Ta), t[h]: L80 / B10 @ 25 °C (Ta), t[h]: L90 / B10 @ 25 °C (Ta)

## Control gear







Output current	700 mA
ECG - Output ripple current	< 7 %



ECG - Length	116.7 mm
ECG - Width	49.9 mm
ECG - Height	27 mm
Recommended control gear	LEDV DR DALI-P-44/220-240/1050

Certificates & Standards

Standards	CE / CB / TÜV / UKCA / EAC / EPD
Luminaire with limited surface temperature, "D sign"	No
Ball shot safe	No
EPD	LEDV-00008-V01.01-EN
Replaceable light source (EPREL)	Not replaceable

Accessories Optional









Product image	Product name	EAN
	DR DALI - P -44/220-240/1050	4058075779723
	DR AY ZB+DALI CLAMP DUO	4058075483125
	EM CONVERSION BOX	4058075237025
	CONNECTOR BOX 5POLE L/N 4x	4058075473010
	PANEL 625 SURFACE MOUNT KIT H70 VAL	4058075402867
	PANEL 625 RECESSED MOUNT FRAME	4058075402904





Product image	Product name	EAN
	PANEL RECESSED MOUNT CLIPS VAL 4x	4058075409859
	PANEL Suspension Kit	4058075402928



**EQUIPMENT / ACCESSORIES**

- Accessories for several mounting options available
- Security brackets preinstalled
- External control gear included
- Suitable for use with separate Emergency Conversion Box

**DOWNLOAD DATA**

Documents and certificates		Document name
	User instruction / safety instructions	UI PANEL COMPACT 2CCT
	Legal information	LISO Insert PL COMP 600 V
	Legal information	EM Insert PL COMP
	Legal information	Informationstext 18 Abs 4 ElektroG
	Declarations of conformity	CE Declaration of Conformity PL COMP V
	Declarations of conformity UKCA	UKCA Declaration of Conformity PL COMP V
Photometric and lighting design files		Document name
	IES file (IES)	PL COMP 625 V 33W 840 U19 EM CONVERSION BOX
	LDT file (Eulumdat)	PL COMP 625 V 33W 840 U19 EM CONVERSION BOX

Photometric and lighting design files		Document name
	ULD file (DIALux)	PL COMP 625 V 33W 840 U19
	ROLF file (RELUX)	PL COMP 625 V 33W 840 U19
	UGR file (UGR table)	PL COMP 625 V 33W 840 U19 EM CONVERSION BOX
	Light distribution curve type cone	PL COMP 625 V 33W 840 U19 EM CONVERSION BOX
	Light distribution curve type polar	PL COMP 625 V 33W 840 U19 EM CONVERSION BOX

CAD/BIM files		Document name
	BIM Revit 3D	Panel Compact
	CAD STEP 3D	PL COMP 625

Tender texts		Document name
	Tender documents	PANEL COMPACT 625 UGR19 33W 840 U19-EN

**LOGISTICAL DATA**

Product code	Packaging unit (Pieces/Unit)	Dimensions (length x width x height)	Gross weight	Volume
4099854017469	Folding box 1	627 mm x 37 mm x 687 mm	2262.00 g	15.94 dm <sup>3</sup>
4099854017476	Shipping box 4	702 mm x 164 mm x 653 mm	9978.00 g	75.18 dm <sup>3</sup>

The mentioned product code describes the smallest quantity unit which can be ordered. One shipping unit can contain one or more single products. When placing an order, for the quantity please enter single or multiples of a shipping unit.

**ADDITIONAL CATALOG INFORMATION**

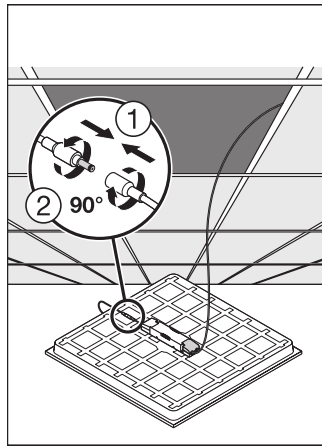
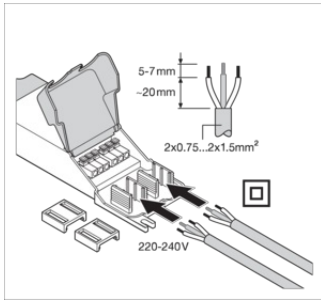

---

### References / Links

– For Guarantee see [www.ledvance.com/guarantee](http://www.ledvance.com/guarantee)

---

### DISCLAIMER

Subject to change without notice. Errors and omission excepted. Always make sure to use the most recent release.