

# PRODUCT DATASHEET

## BIOLUX HCL PL 1200 S 40W TW DALI

BIOLUX HCL PANEL DALI GEN 2 | Recessed panel luminaires, Tunable White, 115 lm/W, tool-free installation, DALI-2 IoT technology

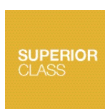

### Areas of application

- Direct replacement for luminaires with fluorescent lamps
- Offices, conference rooms
- Reception areas, foyers and corridors
- Available for grid size of 600 mm x 600 mm, 625 mm x 625 mm and 1200 x 300 mm

### Product benefits

- Suitable luminaire for VIVARES DALI, VIVARES DALI HCL and other DALI-2 light controls
- Enables an individual Tunable White lighting solution in combination with compatible DALI-2 lighting controls
- Light quality of CRI 90 supports increased well-being in HCL applications
- 7 year system guarantee when operated in a VIVARES DALI system
- Compatible with VIVARES CLOUD SERVICE for energy monitoring
- Through-wiring possible with included cable clamp
- External DALI-2 driver for extended flexibility and easy installation
- Good glare reduction (UGR < 19)

### Product features

- IoT-ready luminaire with DALI-2 technology
- Adjustable color temperature via Tunable White: 2,700...6,500 K
- Very high color rendering index Ra: > 90
- High quality extruded aluminum frame



- Version available with pre-mounted Wago-connector (Item No: WAGO 771-9985/206-301) for Panel 625 CSW
- Suitable for central battery emergency installations acc. to EN 60598-2-22

## TECHNICAL DATA

### Electrical data

Nominal wattage	40.00 W
Nominal voltage	220...240 V
Mains frequency	0/50/60 Hz
Nominal current	190.000 mA
Inrush current	27 A
Inrush current time $T_{h50}$	205 $\mu$ s
Max. number of luminaires per miniature circuit breaker B16	23
Max. number of luminaires per miniature circuit breaker C10	23
Max. number of luminaires per miniature circuit breaker C16	36
Power factor $\lambda$	> 0.90
Total harmonic distortion	< 20 %
Protection class	II
Operating mode	External LED driver
Dimming interface	DALI-2 / IoT

### Photometrical data

Luminous flux	4100 lm
Luminous efficacy	102 lm/W
Color temperature	2700...6500 K
Light color (designation)	Tunable White
Color rendering index Ra	> 90
Standard deviation of color matching	3 sdc <sub>m</sub>
Low flicker	Yes
Flickering metric (Pst LM)	$\leq 1$
Stroboscope effect metric (SVM)	$\leq 0.4$
Photobiological safety group acc. to EN62778	RG0
Beam angle	90 °
UGR	< 19

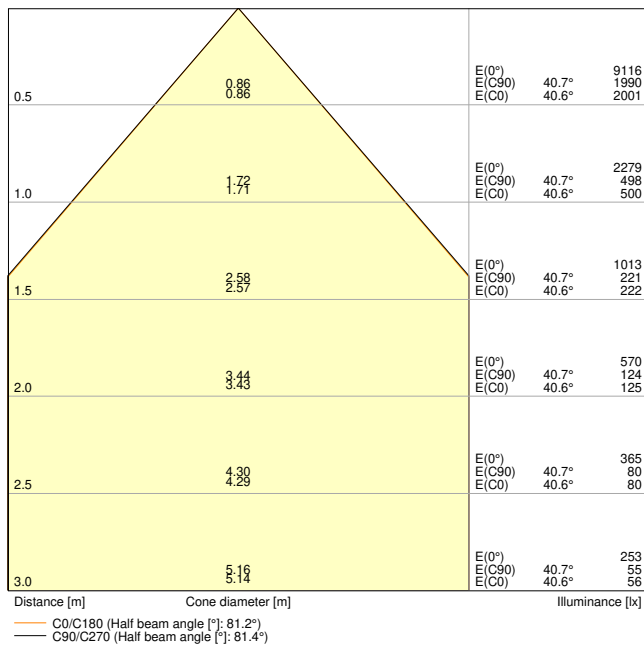

BIOLUX HCL PL 1200 S 40W TW DALI

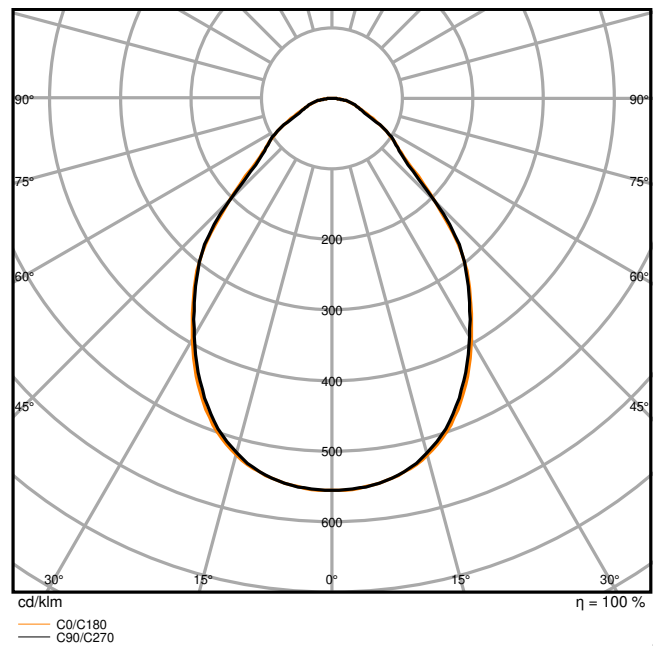

BIOLUX HCL PL 1200 S 40W TW DALI

Dimensions & Weight

Length	1195.00 mm
Width	295.00 mm
Height	11.00 mm
Product weight	3300.00 g

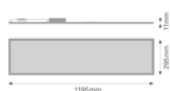

BIOLUX HCL PL 1200 S 40W TW DALI

Materials & Colors

Product color	White
Housing color	White
Body material	Aluminum
Cover material	Polymethylmethacrylate (PMMA)

Light emitting surface material	PMMA
Glow Wire Test according to IEC 60695-2-12	650 °C
Mercury content	0.0 mg

### Application & Mounting

Ambient temperature range	-20...+40 °C
Temperature range at storage	-20...+80 °C
Type of connection	Screwless terminal, 5-Pole (L, N, PE, DA+, DA-)
Type of protection	IP20/IP20
Protection class IK (shock resistance)	IK02
Dimmable	Yes
Type of dimming	DALI2
Dimming range	1...100 %
Mounting type	Recessed
Mounting location	Ceiling / Wall
Application environment	Indoor
Mounting length	1190 mm
Mounting width	290 mm
Mounting depth	50,0 mm
Adjustable	No
With light source	Yes

### Lifespan

Lifespan L70/B50 at 25 °C	70000 h <sup>1)</sup>
Lifespan L80/B10 at 25 °C	40000 h <sup>1)</sup>
Lifespan L80/B50 at 25 °C	40000 h
Lifespan L90/B10 at 25 °C	25000 h
Number of switching cycles	50000

<sup>1)</sup> t[h]: L70 / B50 @ 25 °C (Ta), t[h]: L80 / B10 @ 25 °C (Ta), t[h]: L90 / B10 @ 25 °C (Ta)

### Control gear

Output current	1100 mA
ECG - Output ripple current	< 1 %
ECG - Length	215 mm
ECG - Width	92 mm
ECG - Height	25 mm







Certificates & Standards

Standards	CE / CB / ENEC / UKCA / EAC
Luminaire with limited surface temperature, "D sign"	No
Ball shot safe	No
Replaceable light source (EPREL)	Not replaceable

Additional product data

Added function	VIVARES / BIOLUX
----------------	------------------

Accessories Optional















Product image	Product name	EAN
	PANEL 1200x300 RECESSED MOUNT FRAME	4058075472976
	PANEL 1200 Surface Mount Kit	4058075108820
	PANEL RECESSED MOUNT CLIPS VAL 4x	4058075409859
	PANEL Suspension Kit	4058075402928
	PANEL 1200 X 300 SF MOUNT KIT H70 VAL	4099854018497
	PANEL SECURITY KIT 4x	4058075472990



EQUIPMENT / ACCESSORIES

– Accessories for several mounting options available

- External control gear included
- Security kit (security wire and brackets) included
- Cable clamp for through wiring preinstalled

DOWNLOAD DATA

Documents and certificates		Document name
	User instruction / safety instructions	UI BIOLUX HCL PL 1200 DALI
	Legal information	LISO Insert BIOLUX HCL PL 1200 DALI
	Legal information	Legal insert BIOLUX HCL DALI
	Legal information	Informationstext 18 Abs 4 ElektroG
	Declarations of conformity	BIOLUX HCL PL
	Declarations of conformity UKCA	BIOLUX HCL PL
	Certificates	BIOLUX HCL PL
Photometric and lighting design files		Document name
	IES file (IES)	BIOLUX HCL PL 1200 S 40W TW DALI
	LDT file (Eulumdat)	BIOLUX HCL PL 1200 S 40W TW DALI
	ULD file (DIALux)	BIOLUX HCL PL 1200 S 40W TW DALI
	ROLF file (RELUX)	BIOLUX HCL PL DALI GEN2 1200 S 40W TW
	UGR file (UGR table)	BIOLUX HCL PL 1200 S 40W TW DALI
	Light distribution curve type cone	BIOLUX HCL PL 1200 S 40W TW DALI
	Light distribution curve type polar	BIOLUX HCL PL 1200 S 40W TW DALI
	Spectral power distribution	BIOLUX HCL PL S 40W TW DALI

CAD/BIM files		Document name
	BIM Revit 3D	Biolux Tunable White Panel G2
	CAD STEP 3D	HCL PL 1200

Tender texts		Document name
	Tender documents	BIOLUX HCL PANEL DALI GEN 2 1200 S 40W TW DALI-EN

**LOGISTICAL DATA**

Product code	Packaging unit (Pieces/Unit)	Dimensions (length x width x height)	Gross weight	Volume
4099854140228	Folding box 1	1,308 mm x 51 mm x 374 mm	3896.00 g	24.95 dm <sup>3</sup>
4099854140235	Shipping box 2	1,328 mm x 123 mm x 397 mm	8742.00 g	64.85 dm <sup>3</sup>

The mentioned product code describes the smallest quantity unit which can be ordered. One shipping unit can contain one or more single products. When placing an order, for the quantity please enter single or multiples of a shipping unit.

**ADDITIONAL CATALOG INFORMATION**



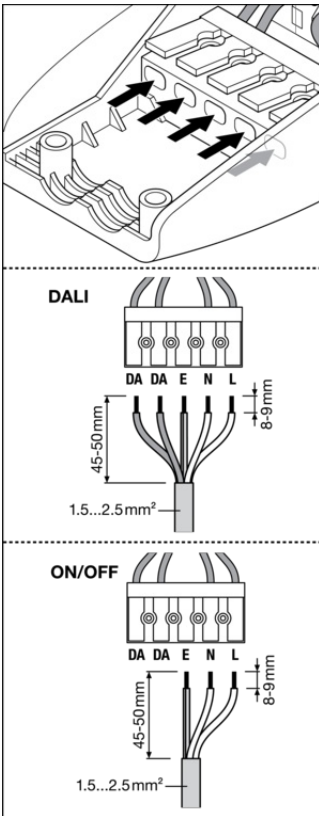

≤ 16 A	B10	B16	B25	B32	C10	C16	DALI	t <sub>c</sub>
BIOLUX HCL PL 1200 S 40W TW DALI	14x	23x	35x	46x	23x	36x	OSRAM DTI DALI 20P 20P...20P 14x NFC TW	-15°C

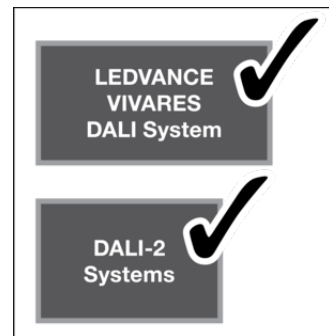

**ACCESSORIES**

- SURFACE MOUNT KIT
- SURFACE MOUNT KIT VALUE
- SUSPENSION KIT
- RECESSED MOUNT FRAME
- RECESSED MOUNT CLIPS

**D** **GB**

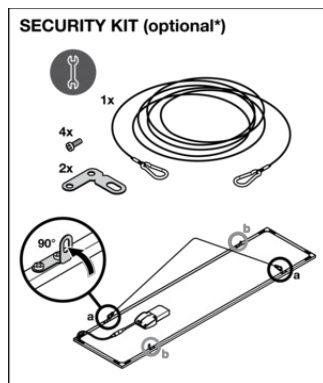

References / Links

– For Guarantee see [www.ledvance.com/guarantee](http://www.ledvance.com/guarantee)

DISCLAIMER

Subject to change without notice. Errors and omission excepted. Always make sure to use the most recent release.