

PRODUCT DATASHEET

SF SQUARE 330 V 24W 830 IP44

SURFACE SQUARE 330 | Wall and ceiling luminaire with IP44



Areas of application

- Corridors
- Stairways
- Bathrooms
- Foyers

Product benefits

- Indoor luminaire with high luminous efficacy
- Energy savings of up to 55 % compared to luminaires that use CFL
- Easy and quick installation
- Very homogenous light
- 3 years guarantee

Product features

- Type of protection: IP44 (ceiling mounting), IP20 (wall mounting)
- Impact resistance: IK03
- Metal housing, PMMA cover
- Ambient temperature in operation: -20...+40 °C
- Indoor use only, not suitable for outdoor use



TECHNICAL DATA

Electrical data

Nominal wattage	24.00 W
Nominal voltage	220...240 V
Mains frequency	50...60 Hz
Nominal current	115.000 mA
Inrush current	7.2 A
Inrush current time T_{h50}	5.9 μ s
Max. number of luminaires per miniature circuit breaker B16	104
Max. number of luminaires per miniature circuit breaker C10	66
Max. number of luminaires per miniature circuit breaker C16	106
Power factor λ	> 0.70
Total harmonic distortion	< 60 %
Protection class	I
Operating mode	Integrated LED driver

Photometrical data

Luminous flux	2000 lm
Luminous efficacy	83 lm/W
Color temperature	3000 K
Light color (designation)	Warm White
Color rendering index Ra	> 80
Standard deviation of color matching	< 6 sdc _m
Low flicker	Yes
Flickering metric (Pst LM)	< 1
Stroboscope effect metric (SVM)	< 0.4
Photobiological safety group acc. to EN62778	RG0
Beam angle	120 °

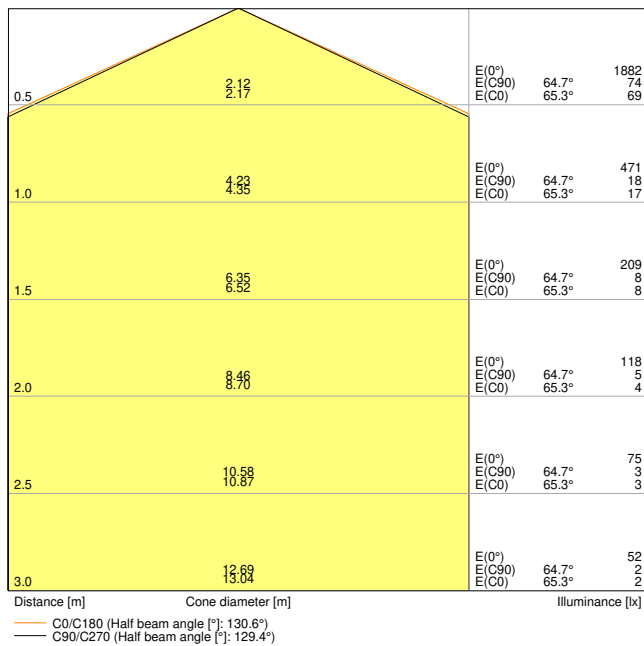

SF SQUARE 330 V 24W 3000K IP44

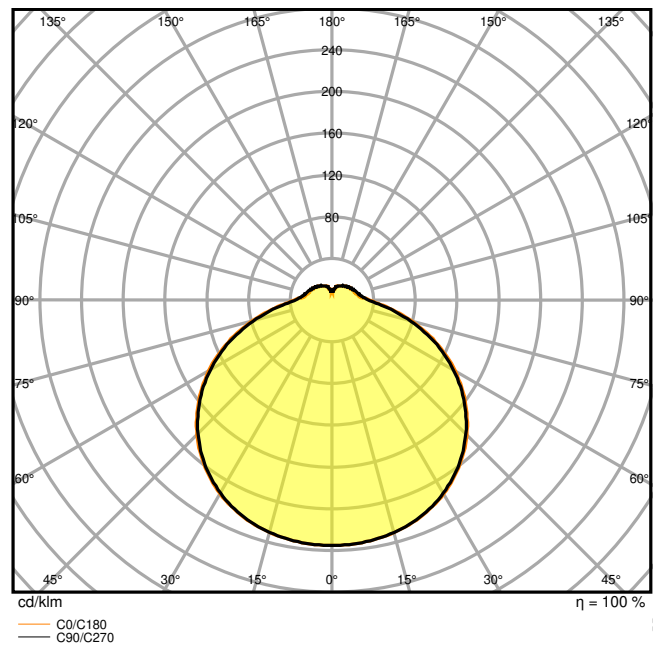

SF SQUARE 330 V 24W 3000K IP44

Dimensions & Weight

Length	330.00 mm
Width	330.00 mm
Height	75.00 mm
Product weight	655.00 g

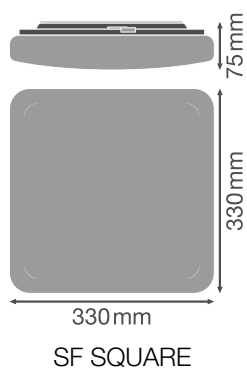

Materials & Colors

Product color	White
Housing color	White
Body material	Steel
Cover material	Polymethylmethacrylate (PMMA)
Light emitting surface material	PMMA
Glow Wire Test according to IEC 60695-2-12	650 °C
Mercury content	0.0 mg

Application & Mounting

Ambient temperature range	-20...+40 °C
Temperature range at storage	-20...+80 °C
Type of connection	Terminal, 3-pin
Type of protection	IP44
Protection class IK (shock resistance)	IK03
Dimmable	No
Mounting type	Surface
Mounting location	Ceiling / Wall
Application environment	Indoor
With light source	Yes

Lifespan

Lifespan L70/B50 at 25 °C	35000 h ¹⁾
Lifespan L80/B10 at 25 °C	33000 h ¹⁾
Lifespan L80/B50 at 25 °C	33000 h
Lifespan L90/B10 at 25 °C	15000 h
Number of switching cycles	100000

¹⁾ t[h]: L70 / B50 @ 25 °C (Ta), t[h]: L80 / B10 @ 25 °C (Ta), t[h]: L90 / B10 @ 25 °C (Ta)

Control gear

Output current	300 mA
ECG - Output ripple current	< 5 %

Certificates & Standards

Standards	CE / CB / TÜV / UKCA / EAC
Luminaire with limited surface temperature, "D sign"	No
Ball shot safe	No















Replaceable light source (EPREL)

Not replaceable

EQUIPMENT / ACCESSORIES

– Replacement cover optionally available

DOWNLOAD DATA

Documents and certificates		Document name
	User instruction / safety instructions	UI SF SQUARE 330 V and SF SQUARE 330 SEN V
	Legal information	LSI SF SQUARE 330 V 24W
	Legal information	Legal insert
	Legal information	Informationstext 18 Abs 4 ElektroG
	Declarations of conformity	SF SQUARE 330 V 24W 830 IP44
	Declarations of conformity UKCA	SF SQUARE and SF CIRC
Photometric and lighting design files		Document name
	IES file (IES)	SF SQUARE 330 V 24W 3000K IP44
	LDT file (Eulumdat)	SF SQUARE 330 V 24W 3000K IP44
	ULD file (DIALux)	SF SQUARE 330V 24W 830 IP44
	ROLF file (RELUX)	SF SQUARE 330 24W 830 IP44
	UGR file (UGR table)	SF SQUARE 330 V 24W 3000K IP44
	Light distribution curve type cone	SF SQUARE 330 V 24W 3000K IP44
	Light distribution curve type polar	SF SQUARE 330 V 24W 3000K IP44
CAD/BIM files		Document name
	BIM Revit 3D	SF SQUARE

CAD/BIM files		Document name
	CAD STEP 3D	SF SQUARE 330

Tender texts		Document name
	Tender documents	SURFACE SQUARE 330 24W 830 IP44-EN

LOGISTICAL DATA

Product code	Packaging unit (Pieces/Unit)	Dimensions (length x width x height)	Gross weight	Volume
4099854041952	Folding box 1	87 mm x 367 mm x 369 mm	916.00 g	11.78 dm ³
4099854041969	Shipping box 5	457 mm x 387 mm x 404 mm	5771.00 g	71.45 dm ³

The mentioned product code describes the smallest quantity unit which can be ordered. One shipping unit can contain one or more single products. When placing an order, for the quantity please enter single or multiples of a shipping unit.

ADDITIONAL CATALOG INFORMATION

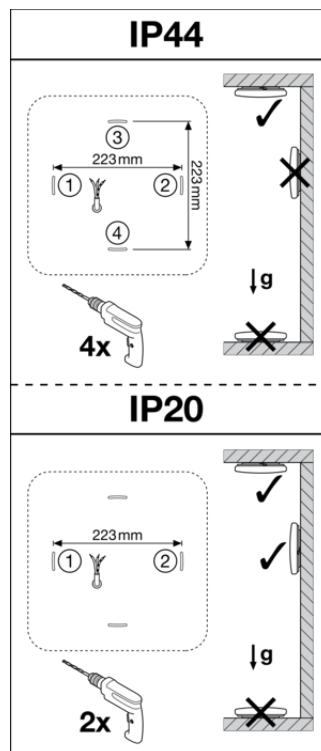
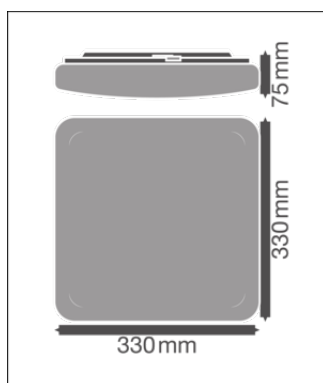

References / Links

– For Guarantee see www.ledvance.com/guarantee

DISCLAIMER

Subject to change without notice. Errors and omission excepted. Always make sure to use the most recent release.