

PRODUCT DATASHEET

PL COMP 600 V 35W 830 840 U19 PS

PANEL COMPACT 600 UGR<19 2CCT | Square recessed panel luminaires with CCT, power select feature and low glare, for 600 x 600 mm ceiling systems



Areas of application

- Direct replacement for luminaires with fluorescent lamps
- Offices, conference rooms
- Reception areas, foyers, corridors, elevators
- Suitable for recessed ceiling systems with grid size of 600 x 600 mm

Product benefits

- Highly versatile due to selectable CCT and power steps (Power Select - PS)
- Good glare reduction (UGR < 19)
- Low flicker light thanks to special electronic control gear
- Energy savings thanks to system efficacy of up to 110 lm/W
- External driver for extended flexibility and easy installation
- Versions with DALI ECG available
- 5 years guarantee

Product features

- Extruded aluminum frame
- Polystyrene diffuser
- Lifetime (L80/B10): up to 50,000 h (at 25 °C)

TECHNICAL DATA

Electrical data

Nominal wattage	35.0 W / 30 W
Nominal voltage	220...240 V
Mains frequency	50...60 Hz
Nominal current	170.000 mA
Inrush current	12.3 A
Inrush current time T_{h50}	52 μ s
Max. number of luminaires per miniature circuit breaker B16	61
Max. number of luminaires per miniature circuit breaker C10	48
Max. number of luminaires per miniature circuit breaker C16	78
Power factor λ	> 0.90
Total harmonic distortion	< 10 %
Protection class	II
Operating mode	External LED driver

Photometrical data

Luminous flux	3300 lm / 3850 lm
Luminous efficacy	110 lm/W
Color temperature	3000 K / 4000 K
Light color (designation)	Warm White / Cool white
Color rendering index Ra	> 80
Standard deviation of color matching	5 sdc _m
Low flicker	Yes
Flickering metric (Pst LM)	<1
Stroboscope effect metric (SVM)	< 0.4
Photobiological safety group acc. to EN62778	RG0
Beam angle	90 °
UGR	< 19

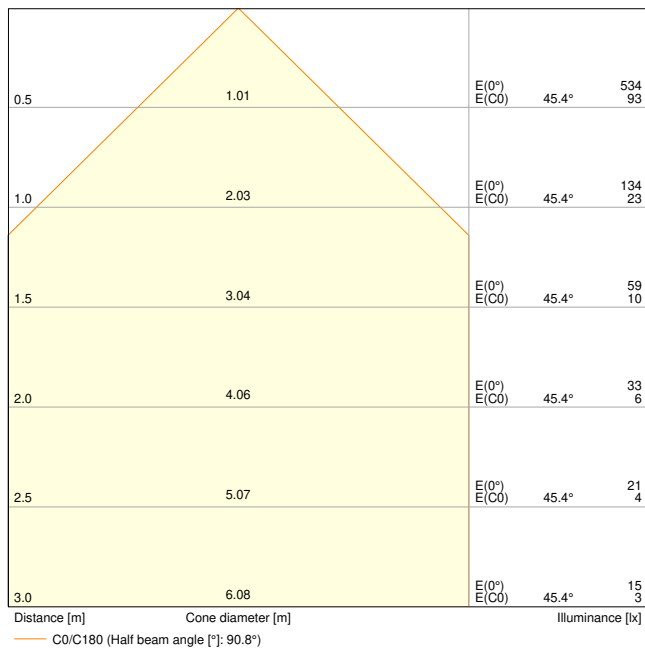

PL COMP 600 V 30W 830 U19 PS 3300lm

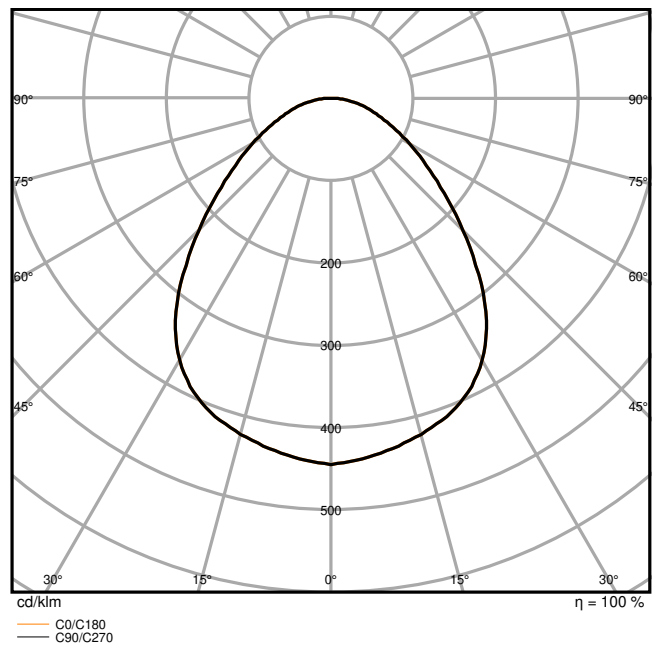

PL COMP 600 V 30W 830 U19 PS 3300lm

Dimensions & Weight

Length	595.00 mm
Width	595.00 mm
Height	32.00 mm
Product weight	1750.00 g

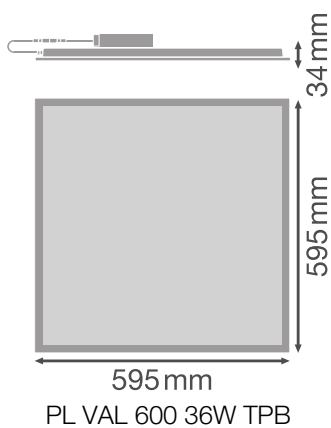

Materials & Colors

Product color	White
Housing color	White

Body material	Steel
Cover material	Polystyrene (PS)
Light emitting surface material	Polystyrene
Glow Wire Test according to IEC 60695-2-12	650 °C
Mercury content	0.0 mg

Application & Mounting

Ambient temperature range	-10...+50 °C
Temperature range at storage	-20...+80 °C
Type of connection	Screwless terminal, 2-Pole (L, N)
Type of protection	IP40/IP20
Protection class IK (shock resistance)	IK02
Dimmable	No
Mounting type	Recessed/Suspended/Surface
Mounting location	Ceiling
Application environment	Indoor
Mounting length	575 mm
Mounting width	595.00 mm
Mounting depth	50,0 mm
Adjustable	No
With light source	Yes

Lifespan

Lifespan L70/B50 at 25 °C	70000 h ¹⁾
Lifespan L80/B10 at 25 °C	50000 h ¹⁾
Lifespan L80/B50 at 25 °C	50000 h
Lifespan L90/B10 at 25 °C	40000 h
Number of switching cycles	50000

¹⁾ t[h]: L70 / B50 @ 25 °C (Ta), t[h]: L80 / B10 @ 25 °C (Ta), t[h]: L90 / B10 @ 25 °C (Ta)

Control gear

Output current	730 mA
ECG - Output ripple current	< 5 %
ECG - Length	116.7 mm
ECG - Width	44 mm
ECG - Height	30,0 mm
Recommended control gear	LEDV DR DALI-P-44/220-240/1050

Certificates & Standards

Standards	CE / CB / TÜV / UKCA / EAC
Luminaire with limited surface temperature, "D sign"	No
Ball shot safe	No
Replaceable light source (EPREL)	Not replaceable







Additional product data



Added function	MULTI SELECT
----------------	--------------







EQUIPMENT / ACCESSORIES



- External control gear included with a switch to select preferred lumen level
- Separate switch preinstalled to choose preferred CCT during installation
- Suitable for use with separate Emergency Conversion Box
- Accessories for several mounting options available
- Security rope for luminaire included
- Security brackets preinstalled

DOWNLOAD DATA

Documents and certificates		Document name
	User instruction / safety instructions	UI PANEL COMPACT 2CCT
	Legal information	LSI PANEL COMPACT 600 625
	Legal information	Legal Insert PL COMP
	Legal information	EM Insert PL COMP
	Legal information	Informationstext 18 Abs 4 ElektroG
	Declarations of conformity	PL COMP 625
	Declarations of conformity UKCA	PL COMP 625

Photometric and lighting design files		Document name
	IES file (IES)	PL COMP 600 V 35W 830 U19 PS 3850lm
	LDT file (Eulumdat)	PL COMP 600 V 35W 830 U19 PS 3850lm
	LDT file (Eulumdat)	PL COMP 600 V 35W 840 U19 PS 3850lm

Photometric and lighting design files		Document name
	LDT file (Eulumdat)	PL COMP 600 V 35W 830 U19 PS 3850lm
	ULD file (DIALux)	PL COMP 600 V 35W 830 840 U19 PS
	ROLF file (RELUX)	PL COMP 600 V 35W 830 840 U19 PS
	UGR file (UGR table)	PL COMP 600 V 30W 830 U19 PS 3300lm
	Light distribution curve type cone	PL COMP 600 V 30W 830 U19 PS 3300lm
	Light distribution curve type polar	PL COMP 600 V 30W 830 U19 PS 3300lm

CAD/BIM files		Document name
	BIM Revit 3D	Panel Compact
	CAD STEP 3D	PL COMP 600

Tender texts		Document name
	Tender documents	PANEL COMPACT 600 UGR19 2CCT 35W 830 840 U19 PS-EN

LOGISTICAL DATA

Product code	Packaging unit (Pieces/Unit)	Dimensions (length x width x height)	Gross weight	Volume
4099854206535	Folding box 1	602 mm x 37 mm x 662 mm	2180.00 g	14.75 dm ³
4099854206542	Shipping box 4	677 mm x 164 mm x 628 mm	9630.00 g	69.73 dm ³

The mentioned product code describes the smallest quantity unit which can be ordered. One shipping unit can contain one or more single products. When placing an order, for the quantity please enter single or multiples of a shipping unit.

ADDITIONAL CATALOG INFORMATION

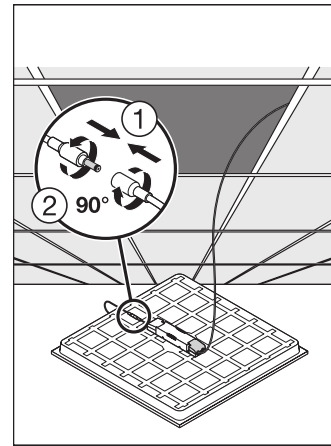
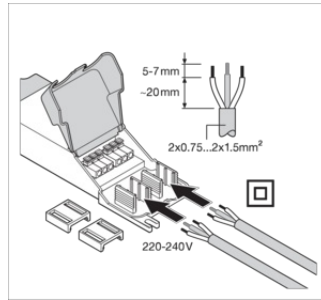
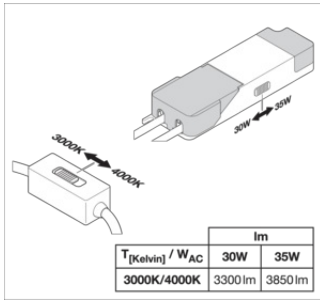

References / Links

– For Guarantee see www.ledvance.com/guarantee

DISCLAIMER

Subject to change without notice. Errors and omission excepted. Always make sure to use the most recent release.