

PRODUCT DATASHEET

PL FLEX 625 S 32W 840 PS

PANEL FLEX 625 PS | Square recessed panel luminaires with power select feature, for 625 x 625 mm ceiling systems

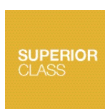

Areas of application

- Suitable for recessed ceiling systems with grid size of 625 x 625 mm
- Direct replacement for recessed luminaires with fluorescent lamps
- Offices, conference rooms
- Reception areas, foyers, corridors, elevators

Product benefits

- Highly versatile due to selectable power steps (Power Select - PS) on the driver and up to 5220 lm
- Energy savings thanks to high system efficacy: up to 170 lm/W
- High color consistency with SDCM 3
- External driver for extended flexibility and easy installation
- Low flicker light thanks to special electronic control gear
- Tool-free electrical connection due to push button connector
- Through-wiring possible with included connector box
- Decentral emergency lighting possible with separately available LEDVANCE Emergency Conversion Box
- Extended services such as energy monitoring and remote maintenance possible with DALI versions
- 7 years guarantee

Product features

- Lifetime (L80/B10): 100,000 h (at 25 °C), (L90/B10): 50,000 h (at 25 °C)
- Suitable for central battery emergency installations acc. to EN 60598-2-22



- 5-pole terminal block, cable cross section up to 5 x 2.5 mm²
- Extruded aluminum frame, metal housing
- Polystyrene diffuser
- Luminaire versions with IoT-ready DALI-2 driver available

TECHNICAL DATA

Electrical data

Nominal wattage	32 W / 27 W / 22 W / 17 W ¹⁾
Nominal voltage	220...240 V
Mains frequency	50...60 Hz
Nominal current	145.000 mA
Inrush current	11.1 A
Inrush current time T_{h50}	600 μ s
Max. number of luminaires per miniature circuit breaker B16	12
Max. number of luminaires per miniature circuit breaker C10	13
Max. number of luminaires per miniature circuit breaker C16	21
Power factor λ	> 0.90
Total harmonic distortion	< 15 %
Protection class	II
Operating mode	External LED driver

¹⁾ The Panel Flex family is fulfilling the technical minimum requirements according to the German BEG subsidy program for energy efficient luminaires

Photometrical data

Luminous flux	5220 lm / 4460 lm / 3680 lm / 2890 lm ¹⁾
Luminous efficacy	163 lm/W / 165 lm/W / 167 lm/W / 170 lm/W ¹⁾
Color temperature	4000 K
Light color (designation)	Cool White
Color rendering index Ra	> 80
Standard deviation of color matching	≤ 3 sdc _m
Low flicker	Yes
Flickering metric (Pst LM)	<1
Stroboscope effect metric (SVM)	<0.4
Photobiological safety group acc. to EN62778	RG0
Beam angle	110 °

¹⁾ The Panel Flex family is fulfilling the technical minimum requirements according to the German BEG subsidy program for energy efficient luminaires

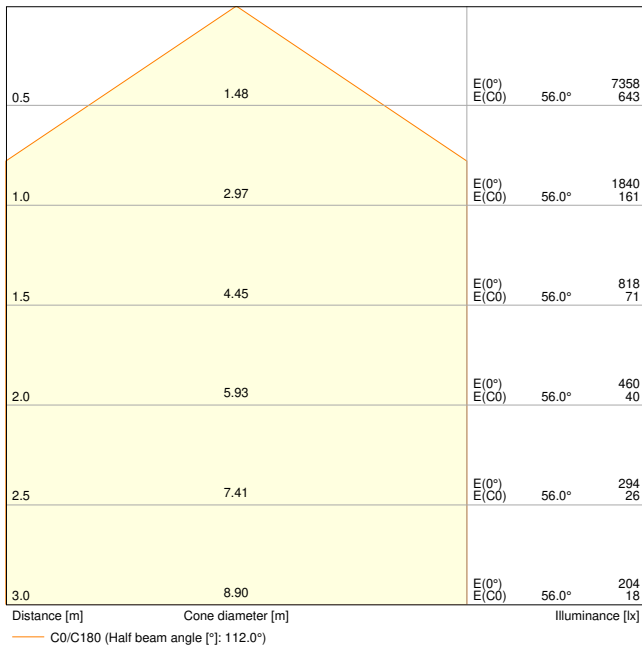

PL FLEX 625 S 32W 4000K 5220lm

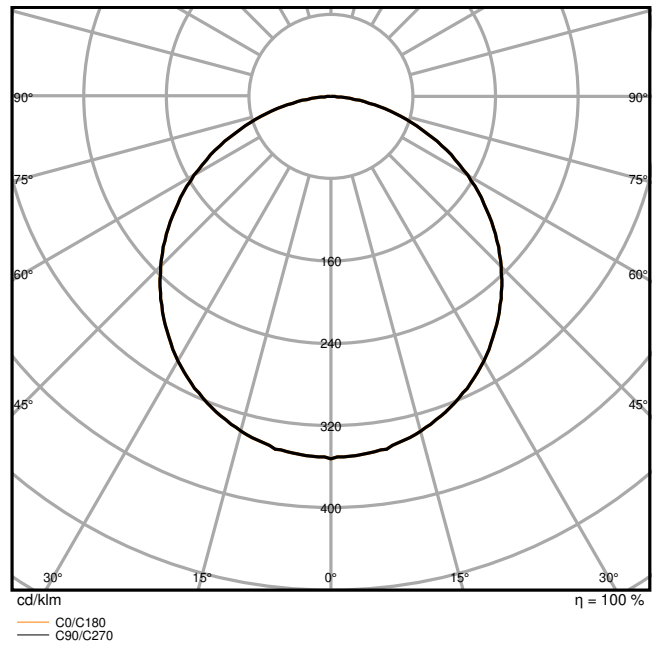

PL FLEX 625 S 32W 4000K 5220lm

Dimensions & Weight

Length	620.00 mm
Width	620.00 mm
Height	32.00 mm
Product weight	1600.00 g

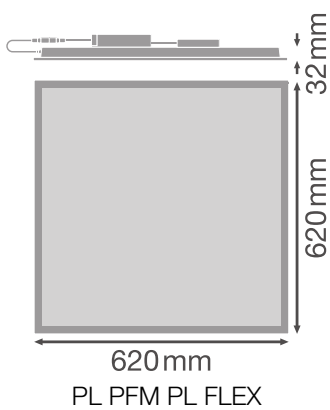

Materials & Colors

Product color	White
Housing color	White
Body material	Aluminum
Cover material	Polystyrene (PS)
Glow Wire Test according to IEC 60695-2-12	650 °C
Mercury content	0.0 mg

Application & Mounting

Ambient temperature range	-10...+50 °C
Temperature range at storage	-20...+80 °C
Type of connection	Screwless terminal, 5-Pole (L, N, PE, DA+, DA-)
Type of protection	IP40/IP20
Protection class IK (shock resistance)	IK02
Dimmable	No
Mounting type	Recessed/Suspended/Surface
Mounting location	Ceiling
Application environment	Indoor
Mounting length	620 mm
Mounting width	620 mm
Mounting depth	50 mm
Adjustable	No
With light source	Yes

Lifespan

Lifespan L70/B50 at 25 °C	100000 h ¹⁾
Lifespan L80/B10 at 25 °C	100000 h ¹⁾
Lifespan L80/B50 at 25 °C	100000 h
Lifespan L90/B10 at 25 °C	50000 h
Number of switching cycles	100000

¹⁾ t[h]: L70 / B50 @ 25 °C (Ta), t[h]: L80 / B10 @ 25 °C (Ta), t[h]: L90 / B10 @ 25 °C (Ta)

Control gear

Output current	750 mA
ECG - Output ripple current	< 5 %
ECG - Length	125 mm
ECG - Width	60 mm

ECG - Height	30 mm
Recommended control gear	DR DS-P-32/220-240/750 PL FLEX 625







Certificates & Standards

Standards	CE / CB / ENEC / UKCA / EAC / EPD / EL
Luminaire with limited surface temperature, "D sign"	No
Ball shot safe	No
Replaceable light source (EPREL)	By the end consumer

Additional product data

Added function	MULTI SELECT
----------------	--------------

Accessories Optional











Product image	Product name	EAN
	DR DS-P- 32/220-240/750 PL FLEX 625	4058075843691
	PANEL 625 SURFACE MOUNT KIT H70 VAL	4058075402867
	PANEL 625 RECESSED MOUNT FRAME	4058075402904
	EM CONVERSION BOX	4058075237025
	PANEL Suspension Kit	4058075402928
	PANEL RECESSED MOUNT CLIPS VAL 4x	4058075409859







Product image	Product name	EAN
	OTi DALI 50/220...240/1A4 NFC	4062172061889

EQUIPMENT / ACCESSORIES

- Accessories for several mounting options available
- Connector box with 5-pole terminal included
- Security brackets preinstalled
- External control gear included
- Suitable for use with separate Emergency Conversion Box
- Serviceable luminaire: Upgrades and replacements available

DOWNLOAD DATA

Documents and certificates		Document name
	User instruction / safety instructions	PANEL FLEX
	Legal information	LSI PANEL FLEX
	Legal information	Legal Insert PL FLEX
	Legal information	Informationstext 18 Abs 4 ElektroG
	Legal information	EM Insert PL FLEX
	Declarations of conformity	PL FLEX
	Declarations of conformity UKCA	PL FLEX
Photometric and lighting design files		Document name
	IES file (IES)	PL FLEX 625 S 32W 4000K 5220lm
	LDT file (Eulumdat)	PL FLEX 625 S 32W 4000K 5220lm
	ULD file (DIALux)	PL FLEX 625 S 32W 840 PS

Photometric and lighting design files		Document name
	UGR file (UGR table)	PL FLEX 625 S 32W 4000K 5220lm
	Light distribution curve type cone	PL FLEX 625 S 32W 4000K 5220lm
	Light distribution curve type polar	PL FLEX 625 S 32W 4000K 5220lm
CAD/BIM files		Document name
	BIM Revit 3D	PL FLEX
	CAD STEP 3D	PL FLEX 625
Tender texts		Document name
	Tender documents	PANEL FLEX 625 PS 32W 840 PS-EN

LOGISTICAL DATA

Product code	Packaging unit (Pieces/Unit)	Dimensions (length x width x height)	Gross weight	Volume
4099854276545	Folding box 1	35 mm x 625 mm x 710 mm	2274.00 g	15.53 dm ³
4099854276552	Shipping box 4	737 mm x 179 mm x 657 mm	10418.00 g	86.67 dm ³

The mentioned product code describes the smallest quantity unit which can be ordered. One shipping unit can contain one or more single products. When placing an order, for the quantity please enter single or multiples of a shipping unit.

ADDITIONAL CATALOG INFORMATION

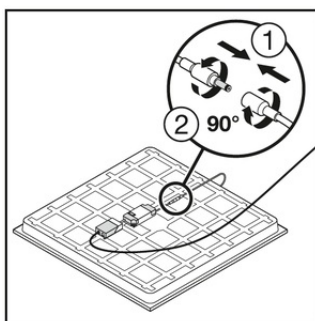
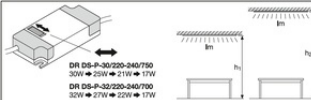
PANEL FLEX 600 / 625*	DRIVER	W x H x D (mm)	W x H x D (mm)	W x H x D (mm)
PL FLEX 600 S 32W 840 PS		30	700	4800
PL FLEX 625 S 32W 840 C10 PS (S2EM W / EN 84-320W DC)		30	600	4150
		21	600	3510
		30	700	4800
		20	600	4150
		21	600	3400
		17	410	3000
		27	600	4400
		30	700	4800
		27	600	4180
		30	700	5100
		27	600	4180
		17	410	2900
		30	700	4800
		27	600	4180
		30	700	5000
		30	750	5100
		30	750	5100

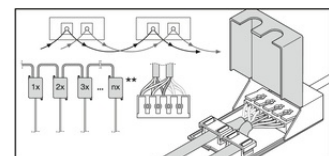

References / Links

- For Guarantee see www.ledvance.com/guarantee

DISCLAIMER

Subject to change without notice. Errors and omission excepted. Always make sure to use the most recent release.