

# PRODUCT DATASHEET

## PL FLEX 625 DALI S 32W 830 U19

PANEL FLEX 625 UGR<19 DALI | Square recessed panel luminaire with low glare, for 625 x 625 mm ceiling systems and DALI-2 technology



### Areas of application

- Suitable for recessed ceiling systems with grid size of 625 x 625 mm
- Direct replacement for recessed luminaires with fluorescent lamps
- Offices, conference rooms
- Reception areas, foyers, corridors, elevators

### Product benefits

- Suitable luminaire for VIVARES and other DALI-2 Light Management Systems
- High lumen output with up to 5220 lm
- Energy savings thanks to high system efficacy: up to 160 lm/W
- Good glare reduction ( $UGR \leq 19$ )
- High color consistency with SDCM 3
- External driver for extended flexibility and easy installation
- Low flicker light thanks to special electronic control gear
- Tool-free electrical connection due to push button connector
- Through-wiring possible with included connector box
- Decentral emergency lighting possible with separately available LEDVANCE Emergency Conversion Box
- Extended services such as energy monitoring and remote maintenance possible with DALI versions
- 7 years guarantee

### Product features



- IoT-ready luminaire with DALI-2 technology
- Suitable for central battery emergency installations acc. to EN 60598-2-22
- Lifetime (L80/B10): 100,000 h (at 25 °C), (L90/B10): 50,000 h (at 25 °C)
- 5-pole terminal block, cable cross section up to 5 x 2.5 mm<sup>2</sup>
- Extruded aluminum frame, metal housing
- Polystyrene diffuser

## TECHNICAL DATA

### Electrical data

Nominal wattage	32.00 W <sup>1)</sup>
Nominal voltage	220...240 V
Mains frequency	0/50/60 Hz
Nominal current	150.000 mA
Inrush current	4.4 A
Inrush current time T <sub>h50</sub>	440 µs
Max. number of luminaires per miniature circuit breaker B16	40
Max. number of luminaires per miniature circuit breaker C10	41
Max. number of luminaires per miniature circuit breaker C16	66
Power factor λ	> 0.90
Total harmonic distortion	< 15 %
Protection class	II
Operating mode	External LED driver
Dimming interface	DALI-2 / IoT

<sup>1)</sup> The Panel Flex family is fulfilling the technical minimum requirements according to the German BEG subsidy program for energy efficient luminaires

### Photometrical data

Luminous flux	5160 lm <sup>1)</sup>
Luminous efficacy	155 lm/W <sup>1)</sup>
Color temperature	3000 K
Light color (designation)	Warm White
Color rendering index Ra	> 80
Standard deviation of color matching	≤3 sdc <sub>m</sub>
Low flicker	Yes
Flickering metric (Pst LM)	<1
Stroboscope effect metric (SVM)	<0.4
Photobiological safety group acc. to EN62778	RG0
Beam angle	90 °
UGR	< 19

<sup>1)</sup> The Panel Flex family is fulfilling the technical minimum requirements according to the German BEG subsidy program for energy efficient luminaires

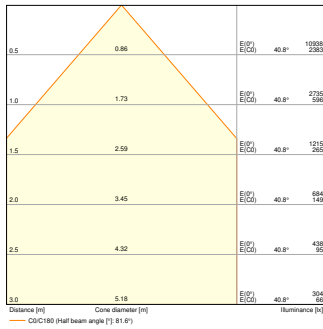

PL FLEX DALI 625 S 32W 3000K  
U19 5160lm

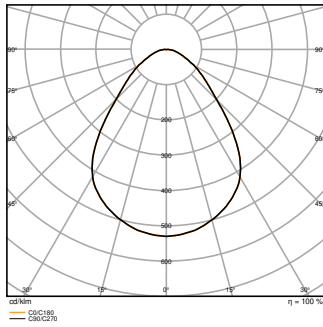

PL FLEX DALI 625 S 32W 3000K  
U19 5160lm

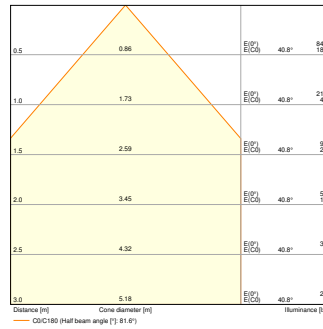

PL FLEX DALI 625 S 3W 3000K  
U19 400lm EM BOX

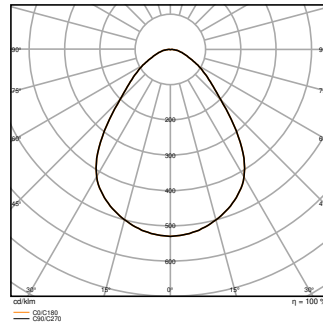

PL FLEX DALI 625 S 3W 3000K  
U19 400lm EM BOX

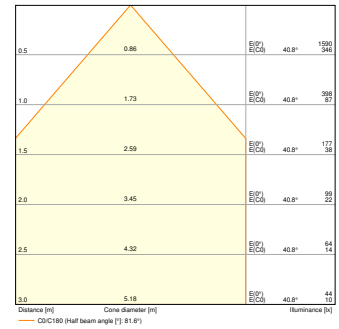

PL FLEX DALI 625 S 6W 3000K  
U19 750lm EM

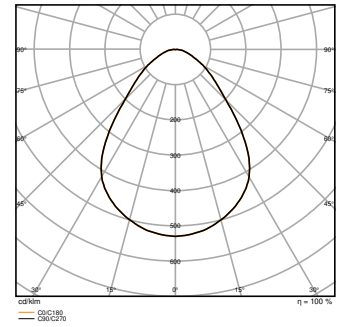

PL FLEX DALI 625 S 6W 3000K  
U19 750lm EM

Dimensions & Weight

Length	620.00 mm
Width	620.00 mm
Height	32.00 mm
Product weight	1700.00 g

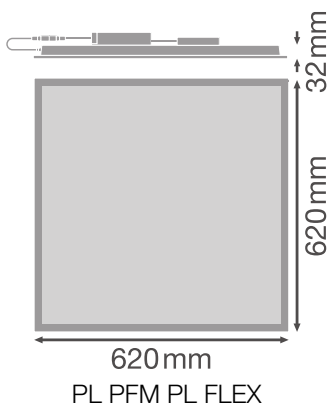

## Materials & Colors

Product color	White
Housing color	White
Body material	Aluminum
Cover material	Polystyrene (PS)
Glow Wire Test according to IEC 60695-2-12	650 °C
Mercury content	0.0 mg

## Application & Mounting

Ambient temperature range	-10...+50 °C
Temperature range at storage	-20...+80 °C
Type of connection	Screwless terminal, 5-Pole (L, N, PE, DA+, DA-)
Type of protection	IP40/IP20
Protection class IK (shock resistance)	IK02
Dimmable	Yes
Type of dimming	DALI2
Mounting type	Recessed/Suspended/Surface
Mounting location	Ceiling
Application environment	Indoor
Mounting length	620 mm
Mounting width	620 mm
Mounting depth	50 mm
Adjustable	No
With light source	Yes

## Lifespan

Lifespan L70/B50 at 25 °C	100000 h <sup>1)</sup>
Lifespan L80/B10 at 25 °C	100000 h <sup>1)</sup>
Lifespan L80/B50 at 25 °C	100000 h
Lifespan L90/B10 at 25 °C	50000 h
Number of switching cycles	100000

<sup>1)</sup> t[h]: L70 / B50 @ 25 °C (Ta), t[h]: L80 / B10 @ 25 °C (Ta), t[h]: L90 / B10 @ 25 °C (Ta)

## Control gear

Output current	750 mA
ECG - Output ripple current	< 5 %

ECG - Length	110 mm
ECG - Width	75 mm
ECG - Height	25 mm
Recommended control gear	OTi DALI 50/220...240/1A4 NFC

**Emergency lighting**

Wattage in emergency operation mode	6 W
Luminous flux in emergency operation mode	700 lm





**Certificates & Standards**



Standards	CE / CB / ENEC / UKCA / EAC / EPD / EL
Luminaire with limited surface temperature, "D sign"	No
Ball shot safe	No
Replaceable light source (EPREL)	By the end consumer

**Additional product data**

Added function	VIVARES
----------------	---------

**Accessories Optional**







Product image	Product name	EAN
	DR DS-P- 32/220-240/750 PL FLEX 625	4058075843691
	PANEL 625 SURFACE MOUNT KIT H70 VAL	4058075402867
	PANEL 625 RECESSED MOUNT FRAME	4058075402904
	EM CONVERSION BOX	4058075237025



















Product image	Product name	EAN
	PANEL Suspension Kit	4058075402928
	PANEL RECESSED MOUNT CLIPS VAL 4x	4058075409859
	OTi DALI 50/220...240/1A4 NFC	4062172061889

## EQUIPMENT / ACCESSORIES

- Accessories for several mounting options available
- Connector box with 5-pole terminal included
- Security brackets preinstalled
- External control gear included
- Suitable for use with separate Emergency Conversion Box
- Serviceable luminaire: Upgrades and replacements available

## DOWNLOAD DATA

Documents and certificates	Document name
 User instruction / safety instructions	PANEL FLEX
 Legal information	LSI PANEL FLEX
 Legal information	Legal Insert PL FLEX
 Legal information	Informationstext 18 Abs 4 ElektroG
 Legal information	EM Insert PL FLEX
 Declarations of conformity	PL FLEX
 Declarations of conformity UKCA	PL FLEX

Photometric and lighting design files		Document name
	IES file (IES)	PL FLEX DALI 625 S 32W 3000K U19 5160lm
	IES files (IES, additional)	PL FLEX DALI 625 S 3W 3000K U19 400lm EM BOX
	IES files (IES, additional)	PL FLEX DALI 625 S 6W 3000K U19 750lm EM
	LDT file (Eulumdat)	PL FLEX DALI 625 S 32W 3000K U19 5160lm
	LDT files (Eulumdat, additional)	PL FLEX DALI 625 S 3W 3000K U19 400lm EM BOX
	LDT files (Eulumdat, additional)	PL FLEX DALI 625 S 6W 3000K U19 750lm EM
	ULD file (DIALux)	PL FLEX 625 DALI S 32W 830 U19
	UGR file (UGR table)	PL FLEX DALI 625 S 32W 3000K U19 5160lm
	UGR file (UGR table)	PL FLEX DALI 625 S 3W 3000K U19 400lm EM BOX
	UGR file (UGR table)	PL FLEX DALI 625 S 6W 3000K U19 750lm EM
	Light distribution curve type cone	PL FLEX DALI 625 S 32W 3000K U19 5160lm
	Light distribution curve type cone	PL FLEX DALI 625 S 3W 3000K U19 400lm EM BOX
	Light distribution curve type cone	PL FLEX DALI 625 S 6W 3000K U19 750lm EM
	Light distribution curve type polar	PL FLEX DALI 625 S 32W 3000K U19 5160lm
	Light distribution curve type polar	PL FLEX DALI 625 S 3W 3000K U19 400lm EM BOX
	Light distribution curve type polar	PL FLEX DALI 625 S 6W 3000K U19 750lm EM
CAD/BIM files		Document name
	BIM Revit 3D	PL FLEX
	CAD STEP 3D	PL FLEX 625
Tender texts		Document name
	Tender documents	PANEL FLEX 625 UGR19 DALI 32W 830 U19-EN



LOGISTICAL DATA

Product code	Packaging unit (Pieces/Unit)	Dimensions (length x width x height)	Gross weight	Volume
4099854276811	Folding box 1	35 mm x 625 mm x 710 mm	2374.00 g	15.53 dm <sup>3</sup>
4099854276828	Shipping box 4	737 mm x 179 mm x 657 mm	10818.00 g	86.67 dm <sup>3</sup>

The mentioned product code describes the smallest quantity unit which can be ordered. One shipping unit can contain one or more single products. When placing an order, for the quantity please enter single or multiples of a shipping unit.

ADDITIONAL CATALOG INFORMATION

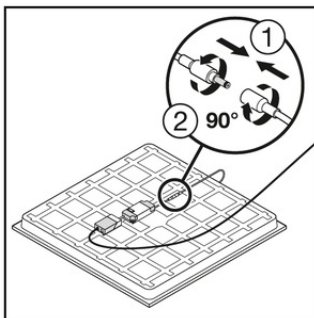

PANEL, FLEX 625 1 625*	DRIVER	W LED M	mA	lm-EM 625	lm/W
PL FLEX 625 S 32W 840 PS		30	700	4380	152
PL FLEX 625 S 32W 840 L10 PS		30	700	4130	138
PL FLEX 625 S 32W 840 L10 PS	DR DS-P-320/220-240/750 PL FLEX 625	21	500	3510	167
PL FLEX 625 S 32W 840 L10 PS	DR DS-P-320/220-240/750 PL FLEX 625	17	410	2880	169
PL FLEX 625 S 32W 840 L10 PS	DR DS-P-320/220-240/750 PL FLEX 625	30	700	4380	152
PL FLEX 625 S 32W 840 L10 PS	DR DS-P-320/220-240/750 PL FLEX 625	21	500	3510	167
PL FLEX 625 S 32W 840 L10 PS	DR DS-P-320/220-240/750 PL FLEX 625	17	410	2880	169
PL FLEX 625 S 32W 840 L10 PS	DR DS-P-320/220-240/750 PL FLEX 625	30	700	4380	152
PL FLEX 625 S 32W 840 L10 PS	DR DS-P-320/220-240/750 PL FLEX 625	21	500	3510	167
PL FLEX 625 S 32W 840 L10 PS	DR DS-P-320/220-240/750 PL FLEX 625	17	410	2880	169
PL FLEX 625 DALI S 32W 840 L10	DR DS-P-320/220-240/750 PL FLEX 625	30	700	4380	152
PL FLEX 625 DALI S 32W 840 L10	DR DS-P-320/220-240/750 PL FLEX 625	21	500	3510	167
PL FLEX 625 DALI S 32W 840 L10	DR DS-P-320/220-240/750 PL FLEX 625	17	410	2880	169
PL FLEX 625 DALI S 32W 840 L10	DR DS-P-320/220-240/750 PL FLEX 625	30	700	4380	152
PL FLEX 625 DALI S 32W 840 L10	DR DS-P-320/220-240/750 PL FLEX 625	21	500	3510	167
PL FLEX 625 DALI S 32W 840 L10	DR DS-P-320/220-240/750 PL FLEX 625	17	410	2880	169

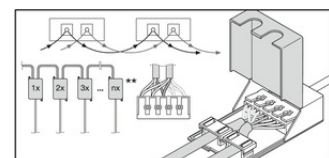

References / Links

– For Guarantee see [www.ledvance.com/guarantee](http://www.ledvance.com/guarantee)

DISCLAIMER

Subject to change without notice. Errors and omission excepted. Always make sure to use the most recent release.