

# PRODUCT DATASHEET

## FL FLEX P 130W ML 830 A45X140 WAL

FLOODLIGHT FLEX ASYMMETRIC 45 X 140 | Floodlight with very wide beam, asymmetric light distribution for area lighting



### Areas of application

- Coastal areas, like ports
- General outdoor area lighting
- Parking
- Suitable for indoor and outdoor sports facilities
- Architectural lighting
- Industry
- Direct replacement for luminaires using HID lamps

### Product benefits

- Corrosion resistance C5: tested in environments with high salinity
- Serviceable luminaire: LED driver can be replaced
- Flexible application due to a range of different lumen packages and beam angles
- 3 cable entries for flexible use and easy connection between luminaires
- Integrated breather for preventing condensation inside the luminaire
- Energy savings of up to 91 % compared to halogen lamp floodlights
- Energy savings of up to 51 % compared to luminaires that use conventional discharge lamps
- No upper light output ratio (ULOR 0%) when mounted at 0° tilt
- Intelligent design of the water drain to prevent standing water
- Simple angle adjustment by locking every 2.5°
- Clear angular degree indication
- Key hole to ensure ease of installation

### Product features



- Corrosion resistance C5 based on 1,500 hours salt mist spray test
- High luminous efficacy: up to 161 lm/W
- Multi Lumen function: 4 power steps selectable
- Daisy chaining possible
- High surge protection: up to 10 kV (L/N-PE), 6 kV (L-N)
- High lifetime (L70/B50): up to 120,000 h (at 25 °C)
- Lumen packages up to 70000 lm
- Additional 2200 K color temperature version available

## TECHNICAL DATA

### Electrical data

Nominal wattage	130 W / 110.5 W / 91.0 W / 71.5 W
Nominal voltage	220...240 V
Mains frequency	50...60 Hz
Nominal current	574.000 mA
Inrush current	65.6 A
Inrush current time $T_{h50}$	190 $\mu$ s
Max. number of luminaires per miniature circuit breaker B16	10
Max. number of luminaires per miniature circuit breaker C10	10
Max. number of luminaires per miniature circuit breaker C16	17
Power factor $\lambda$	> 0.90
Total harmonic distortion	< 20 %
Protection class	I
Surge capability (L-N)	6 kV
Surge capability (L/N-Ground)	10 kV
Operating mode	Integrated LED driver

### Photometrical data

Luminous flux	19000 lm / 16200 lm / 13500 lm / 10800 lm
Luminous efficacy	146 lm/W / 147 lm/W / 148 lm/W / 151 lm/W
Color temperature	3000 K
Light color (designation)	Warm White
Color rendering index Ra	> 80
Standard deviation of color matching	5 sdc <sub>m</sub>
Low flicker	Yes
Flickering metric (Pst LM)	<1
Stroboscope effect metric (SVM)	<0.4
Photobiological safety group acc. to EN62778	RG1
Beam angle	45 ° x 140 °

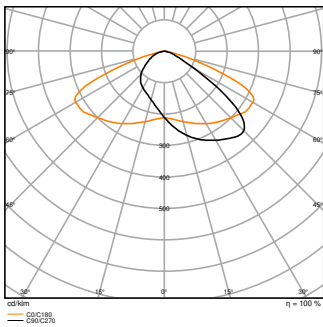

FL FLEX P 130W ML 830 A45X140  
WAL LEDV

### Dimensions & Weight

Length	492.00 mm
Width	361.00 mm
Height	68.00 mm
Product weight	5900.00 g

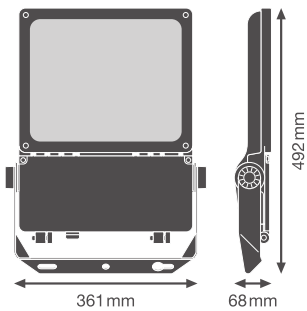

FL FLEX P WAL

### Materials & Colors

Product color	White aluminum
Housing color	White aluminum
Body material	Aluminum
Cover material	Glass
Light emitting surface material	Glass
Glow Wire Test according to IEC 60695-2-12	850 °C

Mercury content	0.0 mg
-----------------	--------

### Application & Mounting

Ambient temperature range	-30...+50 °C
Temperature range at storage	-30...+80 °C
Type of connection	Screwless terminal
Type of protection	IP66
Protection class IK (shock resistance)	IK08
Corrosion resistance class acc. to EN 12944	C5
Dimmable	No
Mounting type	Surface
Mounting location	Wall / Pole / Floor / Ceiling
Application environment	Outdoor
Adjustable	Yes
With light source	Yes

### Lifespan

Lifespan L70/B50 at 25 °C	120000 h <sup>1)</sup>
Lifespan L80/B10 at 25 °C	100000 h <sup>1)</sup>
Lifespan L80/B50 at 25 °C	100000 h
Lifespan L90/B10 at 25 °C	50000 h
Number of switching cycles	100000

<sup>1)</sup> t[h]: L70 / B50 @ 25 °C (Ta), t[h]: L80 / B10 @ 25 °C (Ta), t[h]: L90 / B10 @ 25 °C (Ta)

### Control gear

Output current	3750 mA
ECG - Output ripple current	< 10 %

### Certificates & Standards

Standards	CE / CB / ENEC / UKCA
Luminaire with limited surface temperature, "D sign"	Yes
Replaceable light source (EPREL)	Not replaceable















### Additional product data

Product remark	Available from December 2024
Added function	MULTI SELECT

## EQUIPMENT / ACCESSORIES

- Delivery without cables
- Second cable gland included
- 2 rubber inserts for 6,5 - 7,5 mm cables included

## DOWNLOAD DATA

Documents and certificates		Document name
	User instruction / safety instructions	FL FLEX P ON-OFF
	Legal information	Informationstext 18 Abs 4 ElektroG
	Legal information	Safety Insert G11205497
	Legal information	LSI FL FLEX
	Legal information	Legal insert G11231557
	Declarations of conformity	CE FL FLEX P
	Declarations of conformity UKCA	UKCA FL FLEX P
	Certificates	ENEC FL FLEX P
Photometric and lighting design files		Document name
	IES file (IES)	FL FLEX P 130W ML 830 A45X140 WAL LEDV_IES
	LDT file (Eulumdat)	FL FLEX P 130W ML 830 A45X140 WAL LEDV_LDT
	ULD file (DIALux)	FL FLEX P 130W ML 830 A45X140 WAL
	Light distribution curve type polar	FL FLEX P 130W ML 830 A45X140 WAL LEDV
CAD/BIM files		Document name
	BIM Revit 3D	Floodlight Flex
	BIM Step 3D	FL FLEX 130W

Tender texts	Document name
 Tender documents	FLOODLIGHT FLEX ASYMMETRIC 45 X 140 130W ML 830 A45X140 WAL-en

**LOGISTICAL DATA**

Product code	Packaging unit (Pieces/Unit)	Dimensions (length x width x height)	Gross weight	Volume
4099854373305	Shipping box 1	572 mm x 402 mm x 119 mm	7203.00 g	27.36 dm <sup>3</sup>

The mentioned product code describes the smallest quantity unit which can be ordered. One shipping unit can contain one or more single products. When placing an order, for the quantity please enter single or multiples of a shipping unit.

**ADDITIONAL CATALOG INFORMATION**

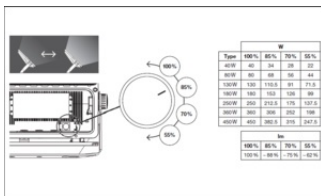

**References / Links**

– For Guarantee see [www.ledvance.com/guarantee](http://www.ledvance.com/guarantee)

**DISCLAIMER**

Subject to change without notice. Errors and omission excepted. Always make sure to use the most recent release.