

PRODUCT DATASHEET

DL SLIM SQ 210 18 W 3000 K WT

DOWNLIGHT SLIM SQUARE | Flat downlights with integrated driver, square shape



Areas of application

- Direct replacement for luminaires with compact fluorescent lamps
- General illumination
- Public areas
- Stairways
- Corridors
- Foyers
- Shops

Product benefits

- Very slim housing
- Low installation depth
- High luminous efficacy
- Energy savings up to 60 % (compared to luminaires that use CFL lamps)
- Very homogenous light
- Functional design
- Easy installation with fast connection
- Simple installation thanks to integrated driver

Product features

- Small visible bezel
- Connector box with push wire terminal for tool-free connection



- Light guide made of non-yellowing PMMA for long lifetime

TECHNICAL DATA

Electrical data

Nominal wattage	18.00 W
Nominal voltage	220...240 V
Mains frequency	50...60 Hz
Nominal current	108 mA
Inrush current	17 A
Inrush current time T_{h50}	56 μ s
Max. number of luminaires per miniature circuit breaker B16	44
Max. number of luminaires per miniature circuit breaker C10	35
Max. number of luminaires per miniature circuit breaker C16	56
Power factor λ	0.50
Total harmonic distortion	< 20 %
Protection class	II
Operating mode	Integrated LED driver

Photometrical data

Luminous flux	1530 lm
Luminous efficacy	85 lm/W
Color temperature	3000 K
Light color (designation)	Warm White
Color rendering index Ra	> 80
Standard deviation of color matching	< 6 sdc _m
Luminous intensity	-
Flickering metric (Pst LM)	-
Stroboscope effect metric (SVM)	-
Photobiological safety group acc. to EN62778	RG0
Photobiological safety group acc. to EN62471	RG0
Beam angle	120 °

0.5	1.41 1.40	E(0°) 2213 E(C90) 216 E(C0) 218
1.0	2.81 2.79	E(0°) 553 E(C90) 54 E(C0) 55
1.5	4.22 4.19	E(0°) 246 E(C90) 24 E(C0) 24
2.0	5.63 5.59	E(0°) 138 E(C90) 13 E(C0) 14
2.5	7.04 6.98	E(0°) 89 E(C90) 9 E(C0) 9
3.0	8.44 8.38	E(0°) 61 E(C90) 6 E(C0) 6

Distance [m] Cone diameter [m] Illuminance [lx]

— C0/C180 (Half beam angle [°]: 108.8°)
— C90/C270 (Half beam angle [°]: 109.2°)

4058075052581 DL SLIM SQ210 18W 3000K WT IP20

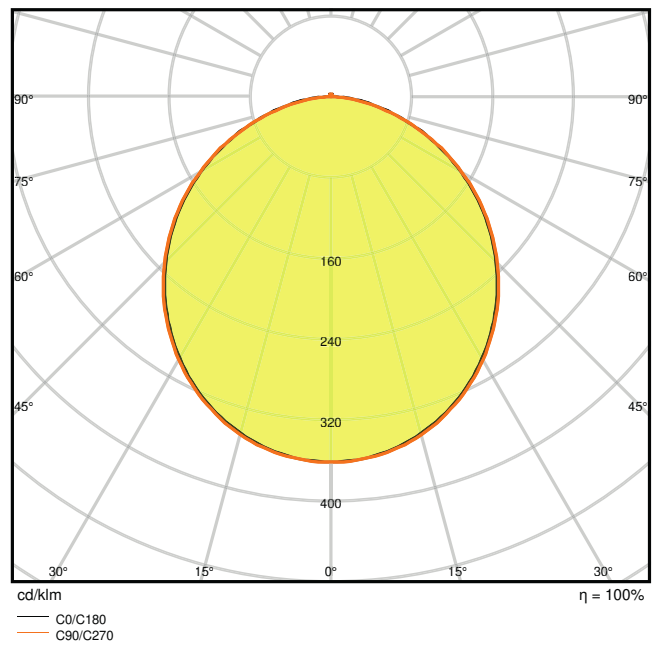

4058075052581 DL SLIM SQ210 18W 3000K WT IP20

Dimensions & Weight

Length	225.00 mm
Width	225.00 mm
Height	30.00 mm
Product weight	527.00 g

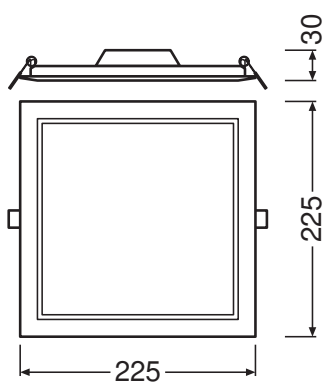

DL Slim SQ210 18W

Materials & Colors

Product color	White
Housing color	White
Body material	Polycarbonate (PC)
Cover material	Polycarbonate (PC)
Light emitting surface material	Polycarbonate (PC)
Glow Wire Test according to IEC 60695-2-12	650 °C
Mercury content	0.0 mg

Application & Mounting

Ambient temperature range	-20...+50 °C
Temperature range at storage	-30...+70 °C
Type of connection	Screwless terminal, 2-Pole
Type of protection	IP20
Protection class IK (shock resistance)	IK03
Dimmable	No
Mounting type	Recessed
Mounting location	Ceiling / Wall
Application environment	Indoor
Mounting length	210,0 mm
Mounting width	210,0 mm
Mounting depth	50,0 mm
With light source	Yes

Lifespan

Lifespan L70/B50 at 25 °C	30000 h ¹⁾
Lifespan L80/B10 at 25 °C	20000 h ¹⁾
Lifespan L80/B50 at 25 °C	20000 h
Lifespan L90/B10 at 25 °C	12000 h
Number of switching cycles	50000

¹⁾ t[h]: L70 / B50 @ 25 °C (Ta), t[h]: L80 / B10 @ 25 °C (Ta), t[h]: L90 / B10 @ 25 °C (Ta)

Control gear

Output current	295 mA
ECG - Output ripple current	< 6.5 %



Certificates & Standards

Standards	CE / CB / EAC
Luminaire with limited surface temperature, "D sign"	No
Ball shot safe	No
Replaceable light source (EPREL)	Not replaceable

Additional product data

Number of illuminants	Not relevant
-----------------------	--------------

Accessories Optional

Product image	Product name	EAN
	DL SLIM FRAME SQ 210 WT	4058075052680
	DL SLIM FRAME SQ 210 WT	4058075079434



EQUIPMENT / ACCESSORIES



- Surface mounting frames available as accessories







Safety advice



- All electrical connections must be made by a qualified person.
- Caution, risk of electric shock.
- The luminaires are not suitable for covering with thermally insulated material.

DOWNLOAD DATA

Documents and certificates	Document name
 Extended installation guide	User Instruction Downlight LED Slim
 On-Pack-Info	Legal Insert Downlight Slim
 Legal information	LSI DL SLIM

Documents and certificates		Document name
	Legal information	Informationstext 18 Abs 4 ElektroG
	Declarations of conformity	CE Certificate downlight Slim
	Declarations of conformity UKCA	DL SLIM WT IP20

Photometric and lighting design files		Document name
	IES file (IES)	DL SLIM SQ210 18W 3000K WT IP20
	LDT file (Eulumdat)	DL SLIM SQ210 18W 3000K WT IP20
	ULD file (DIALux)	DOWNLIGHTSLIMSQUARE21018W3000KWT
	ROLF file (RELUX)	DL SLIM SQ210 18W-3000K
	UGR file (UGR table)	4058075052581 DL SLIM SQ210 18W 3000K WT IP20
	Light distribution curve type cone	4058075052581 DL SLIM SQ210 18W 3000K WT IP20
	Light distribution curve type polar	4058075052581 DL SLIM SQ210 18W 3000K WT IP20

CAD/BIM files		Document name
	BIM Revit 3D	Downlight Slim Square
	CAD STEP 3D	DL SLIM SQ 210

Tender texts		Document name
	Tender documents	DOWNLIGHT SLIM SQUARE 210 18 W 3000 K WT-EN

LOGISTICAL DATA

Product code	Packaging unit (Pieces/Unit)	Dimensions (length x width x height)	Gross weight	Volume
4058075079335	Folding box 1	45 mm x 250 mm x 230 mm	610.00 g	2.59 dm ³
4058075079342	Shipping box 6	290 mm x 260 mm x 250 mm	3991.00 g	18.85 dm ³

The mentioned product code describes the smallest quantity unit which can be ordered. One shipping unit can contain one or more single products. When placing an order, for the quantity please enter single or multiples of a shipping unit.

ADDITIONAL CATALOG INFORMATION

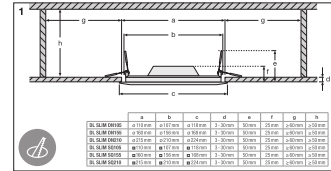
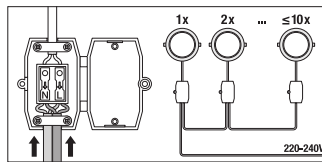
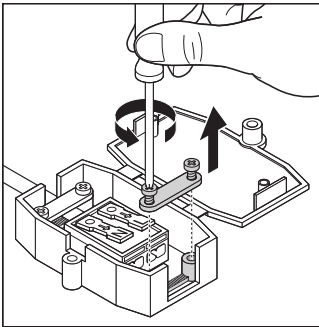

References / Links

– For Guarantee see www.ledvance.com/guarantee

DISCLAIMER

Subject to change without notice. Errors and omission excepted. Always make sure to use the most recent release.