

PRODUCT DATASHEET

SPOT MULTI 1 x 30W 3000K FL WT/BK

SPOT MULTI 1x30W | Recessed mounted spotlight, swivelable with one spot



Areas of application

- Accent- and general lighting for all kind of salesrooms
- Fashion shops, accessories shops
- Shops, boutiques
- Hotel rooms
- Cafés

Product benefits

- Low flicker light thanks to special electronic control gear
- High luminous efficacy
- Covering against other ceiling installations thanks to closed sheet steel housing
- Easy replacement of external driver thanks to plug with bayonet lock
- Functional and minimalistic design
- 5 years guarantee

Product features

- Large faceted reflector for high light output
- Beam angle: 38°
- Gimbal adjustment angle: +/- 25°



TECHNICAL DATA

Electrical data

Nominal wattage	30.00 W
Nominal voltage	220...240 V
Mains frequency	50...60 Hz
Nominal current	135 mA
Inrush current	23 A
Inrush current time T_{h50}	< 3.4 μ s
Max. number of luminaires per miniature circuit breaker B16	32
Max. number of luminaires per miniature circuit breaker C10	26
Max. number of luminaires per miniature circuit breaker C16	41
Power factor λ	≥ 0.90
Total harmonic distortion	< 15 %
Protection class	II
Operating mode	External LED driver

Photometrical data

Luminous flux	2700 lm
Luminous efficacy	90 lm/W
Color temperature	3000 K
Light color (designation)	Warm White
Color rendering index Ra	> 80
Standard deviation of color matching	≤ 4 sdc _m
Luminous intensity	-
Low flicker	Yes
Flickering metric (Pst LM)	-
Stroboscope effect metric (SVM)	-
Photobiological safety group acc. to EN62778	RG1
Beam angle	38 °

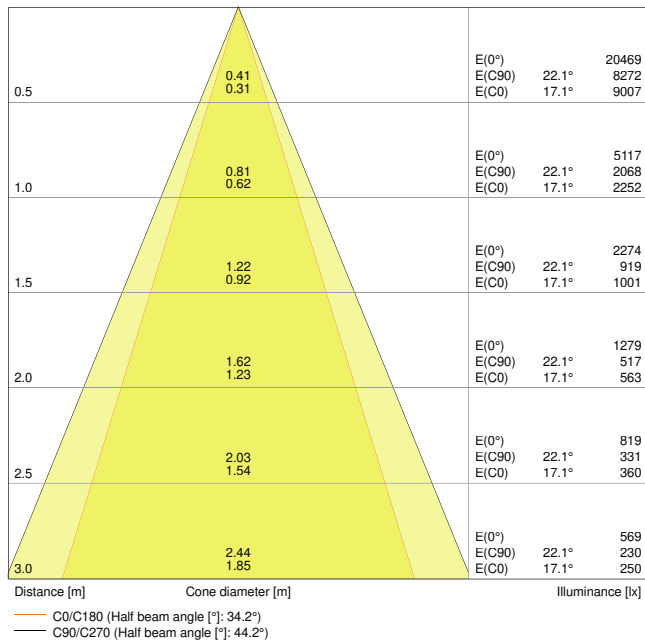

SP MULTI 1 x 30W3000K FL WT

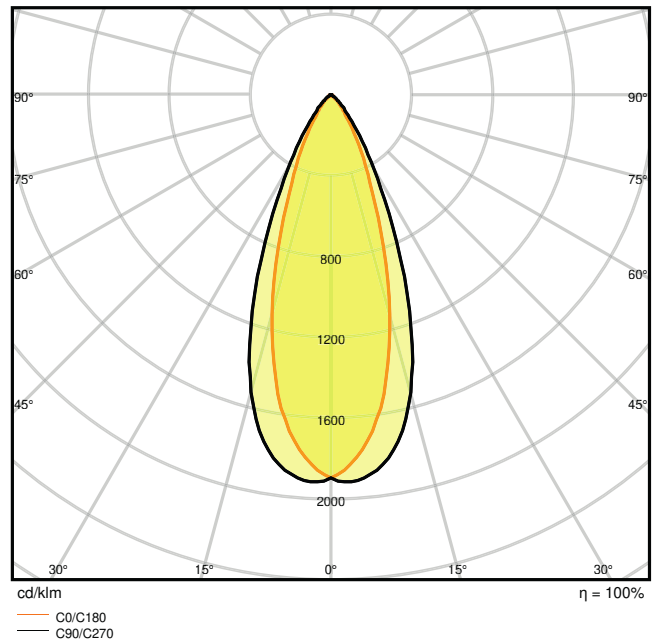

SP MULTI 1 x 30W3000K FL WT

Dimensions & Weight

Length	173.00 mm
Width	173.00 mm
Height	135.00 mm
Product weight	1540.00 g

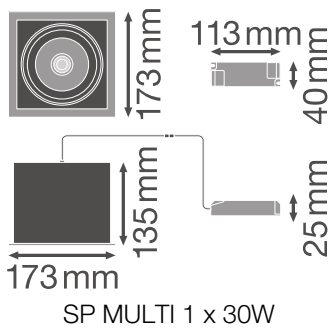

Materials & Colors

Product color	White
---------------	-------

Housing color	White
Body material	Aluminum
Cover material	Polymethylmethacrylate (PMMA)
Glow Wire Test according to IEC 60695-2-12	650 °C
Mercury content	0.0 mg

Application & Mounting

Ambient temperature range	-10...+40 °C
Type of connection	Screw terminal, 2-Pole (L,N)
Type of protection	IP20
Protection class IK (shock resistance)	IK03
Dimmable	No
Mounting type	Recessed
Mounting location	Ceiling
Application environment	Indoor
Mounting length	164,0 mm
Mounting width	160 mm
Mounting depth	250 mm
Adjustable	Yes
With light source	Yes

Lifespan

Lifespan L70/B50 at 25 °C	50000 h ¹⁾
Lifespan L80/B10 at 25 °C	45000 h ¹⁾
Lifespan L80/B50 at 25 °C	45000 h
Lifespan L90/B10 at 25 °C	30000 h
Number of switching cycles	50000

¹⁾ t[h]: L70 / B50 @ 25 °C (Ta), t[h]: L80 / B10 @ 25 °C (Ta), t[h]: L90 / B10 @ 25 °C (Ta)

Control gear

ECG - Length	113 mm
ECG - Width	40 mm
ECG - Height	25 mm

Certificates & Standards

Standards	CE / CB / ENEC / TÜV SÜD / RoHS
-----------	---------------------------------

Luminaire with limited surface temperature, "D sign"	No
Ball shot safe	No
Replaceable light source (EPREL)	Not replaceable











EQUIPMENT / ACCESSORIES







- Driver included

Safety advice

- All electrical connections must be made by a qualified person.
- Caution, risk of electric shock.
- The luminaires are not suitable for covering with thermally insulated material.

DOWNLOAD DATA

	Documents and certificates	Document name
	User instruction / safety instructions	UI Spot Multi
	On-Pack-Info	Legal Insert Spot LED
	Legal information	LSI SP MULTI
	Legal information	Informationstext 18 Abs 4 ElektroG
	Declarations of conformity	Attestation-of-Conformity SP SQ and Multi TÜV
	Declarations of conformity	EU Declaration of Conformity Spot Multi LEDV
	Declarations of conformity UKCA	SP MULTI FL / SP SQUARE DK ADJ FL
	Photometric and lighting design files	Document name
	IES file (IES)	SP MULTI 1 x 30W3000K FL WT
	LDT file (Eulumdat)	SP MULTI 1 x 30W3000K FL WT
	ULD file (DIALux)	SPOTMULTI1x30W3000KFLWTBK

Photometric and lighting design files		Document name
	ROLF file (RELUX)	SP MULTI 1X30W-3000K
	UGR file (UGR table)	SP MULTI 1 x 30W3000K FL WT
	Light distribution curve type cone	SP MULTI 1 x 30W3000K FL WT
	Light distribution curve type polar	SP MULTI 1 x 30W3000K FL WT
CAD/BIM files		Document name
	BIM Revit 3D	Spot Multi
	CAD STEP 3D	SP MULTI 1x30W
Tender texts		Document name
	Tender documents	SPOT MULTI 1x30W 3000K FL WTBK-EN

LOGISTICAL DATA

Product code	Packaging unit (Pieces/Unit)	Dimensions (length x width x height)	Gross weight	Volume
4058075113923	Folding box 1	200 mm x 210 mm x 170 mm	1610.00 g	7.14 dm ³
4058075113930	Shipping box 4	410 mm x 220 mm x 355 mm	6885.00 g	32.02 dm ³

The mentioned product code describes the smallest quantity unit which can be ordered. One shipping unit can contain one or more single products. When placing an order, for the quantity please enter single or multiples of a shipping unit.

ADDITIONAL CATALOG INFORMATION

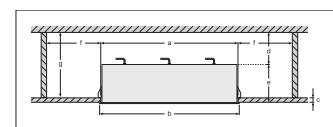
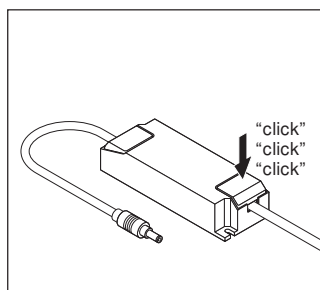
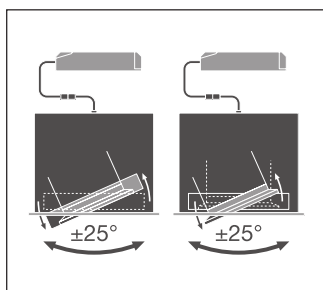

References / Links

– For Guarantee see www.ledvance.com/guarantee

DISCLAIMER

Subject to change without notice. Errors and omission excepted. Always make sure to use the most recent release.