

# PRODUCT DATASHEET

## TR SP ZOOM DIM D85 25 W 3000 K 97R BK

TRACKLIGHT SPOT ZOOM DIM | Dimmable 3-phase tracklight spot with mechanical zoom lens



### Areas of application

- Direct replacement for luminaires using HID lamps
- Accent lighting
- Galleries, museums
- Fashion shops, accessories shops
- Shops, changing rooms, shop windows
- Hotels, restaurants, shops

### Product benefits

- Dimmable 3-phase tracklight spot with mechanical zoom lens
- Included 3-phase adapter compatible with common tracks (GLOBAL, EUTRAC, POWERGEAR, STAFF, NORLUX, NUCO, NORDIC)
- No distraction of attention from the illuminated objects thanks to reduced design
- Low flicker light thanks to special electronic control gear
- 5 years guarantee

### Product features

- Mechanical zoom lens with a beam angle of 15 ° to 55 °
- Dimmable (7% - 100%) via slider potentiometer directly on each luminaire
- Excellent color rendering index CRI 97
- Color rendering index R<sub>a</sub>9: > 90
- Initial color consistency: ≤ 4 SDCM
- Rotation angle: 350°, tilt angle: 90°
- Follows the unified LEDVANCE design language (SCALE design)
- Robust die-cast aluminum housing



- Available in matt white (like RAL9016), matt black (like RAL9004)
- Luminaire efficacy: up to 70 lm/W

## TECHNICAL DATA

### Electrical data

Nominal wattage	25.00 W
Nominal voltage	100...240 V
Mains frequency	50...60 Hz
Nominal current	120 mA
Inrush current	40 A
Inrush current time $T_{h50}$	< 50 $\mu$ s
Max. number of luminaires per miniature circuit breaker B16	37
Max. number of luminaires per miniature circuit breaker C10	30
Max. number of luminaires per miniature circuit breaker C16	48
Power factor $\lambda$	> 0.90
Total harmonic distortion	< 10 %
Protection class	I
Operating mode	Integrated LED driver

### Photometrical data

Luminous flux	1500 lm
Luminous efficacy	60 lm/W
Color temperature	3000 K
Light color (designation)	Warm White
Color rendering index Ra	97
Standard deviation of color matching	$\leq 4$ sdc <sub>m</sub>
Luminous intensity	-
Flickering metric (Pst LM)	-
Stroboscope effect metric (SVM)	-
Photobiological safety group acc. to EN62778	RG1
Beam angle	15°... 55°

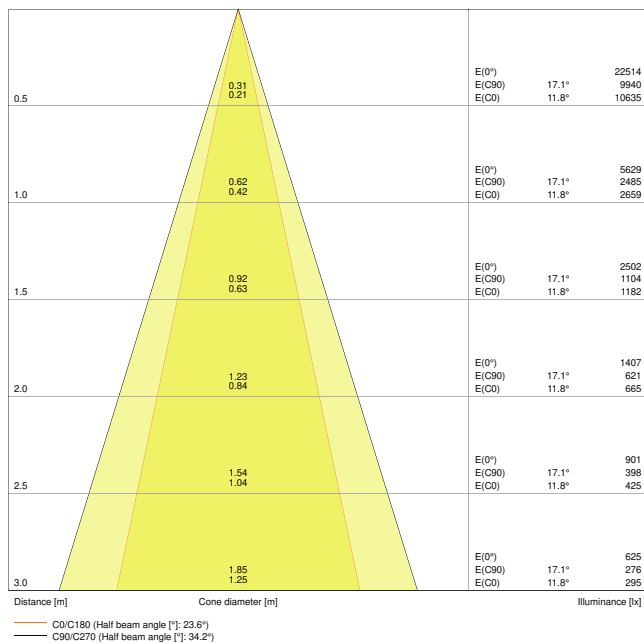

TR SP ZOOM D85 25W 3000K DIM 97R BK 25DEG

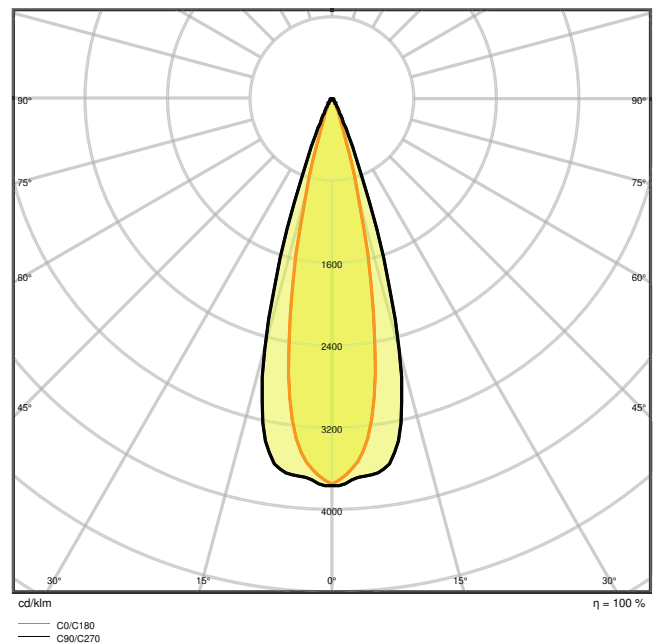

TR SP ZOOM D85 25W 3000K DIM 97R BK 25DEG

### Dimensions & Weight

Diameter	85.00 mm
Length	93.00 mm
Height	265.00 mm
Product weight	1025.00 g

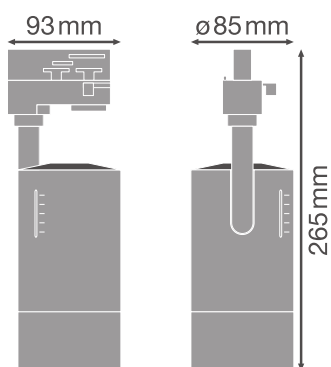

TR SP ZOOM D85

### Materials & Colors

Product color	Black
Housing color	Black
Body material	Aluminum
Cover material	Polycarbonate (PC)
Light emitting surface material	Polycarbonate (PC)
Glow Wire Test according to IEC 60695-2-12	850 °C
Mercury content	0.0 mg

### Application & Mounting

Ambient temperature range	-20...+40 °C
Type of connection	Adapter, 3-phase
Type of protection	IP20
Protection class IK (shock resistance)	IK03
Dimmable	Yes
Type of dimming	1-10V
Mounting type	Surface
Mounting location	Mounting track
Application environment	Indoor
Adjustable	Yes
With light source	No

### Lifespan

Lifespan L70/B50 at 25 °C	50000 h <sup>1)</sup>
Lifespan L80/B10 at 25 °C	35000 h <sup>1)</sup>
Lifespan L80/B50 at 25 °C	35000 h
Lifespan L90/B10 at 25 °C	25000 h
Number of switching cycles	100000

<sup>1)</sup> t[h]: L70 / B50 @ 25 °C (Ta), t[h]: L80 / B10 @ 25 °C (Ta), t[h]: L90 / B10 @ 25 °C (Ta)

### Control gear

ECG - Output voltage	27...42 V
ECG - Output ripple current	< 10 %

### Certificates & Standards













Standards	CE / CB / ENEC / TÜV SÜD / EAC / RoHS
Luminaire with limited surface temperature, "D sign"	No



Ball shot safe	No
Replaceable light source (EPREL)	Not replaceable

### Safety advice

- All electrical connections must be made by a qualified person.
- Caution, risk of electric shock.

### DOWNLOAD DATA

Documents and certificates		Document name
	User instruction / safety instructions	TRACKLIGHT SPOT ZOOM D85
	Legal information	LS Insert TR SP ZOOM
	Legal information	TRACKLIGHT SPOT ZOOM D85
	Legal information	Informationstext 18 Abs 4 ElektroG
	Declarations of conformity	CE declaration TR SP ZOOM
	Declarations of conformity UKCA	TRACK SP
Photometric and lighting design files		Document name
	IES file (IES)	TR SP ZOOM D85 25W 3000K DIM 97R BK 25DEG
	LDT file (Eulumdat)	TR SP ZOOM D85 25W3000K DIM 97R BK
	ULD file (DIALux)	TR SP ZOOM D85 25W-3000K DIM 97R BK
	ROLF file (RELUX)	TR SP ZOOM D85 25W-3000K
	UGR file (UGR table)	TR SP ZOOM D85 25W 3000K DIM 97R BK 25DEG
	Light distribution curve type cone	TR SP ZOOM D85 25W 3000K DIM 97R BK 25DEG
	Light distribution curve type polar	TR SP ZOOM D85 25W 3000K DIM 97R BK 25DEG

CAD/BIM files		Document name
	BIM Revit 3D	TRACKLIGHT SPOT ZOOM
	CAD STEP 3D	TR SPOT ZOOM

Tender texts		Document name
	Tender documents	TRACKLIGHT SPOT ZOOM DIM D85 25 W 3000 K 97R BK-EN

**LOGISTICAL DATA**

Product code	Packaging unit (Pieces/Unit)	Dimensions (length x width x height)	Gross weight	Volume
4058075335806	Folding box 1	120 mm x 120 mm x 300 mm	1146.00 g	4.32 dm <sup>3</sup>
4058075335813	Shipping box 4	502 mm x 137 mm x 335 mm	4902.00 g	23.04 dm <sup>3</sup>

The mentioned product code describes the smallest quantity unit which can be ordered. One shipping unit can contain one or more single products. When placing an order, for the quantity please enter single or multiples of a shipping unit.

**ADDITIONAL CATALOG INFORMATION**

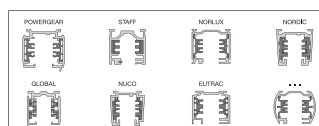
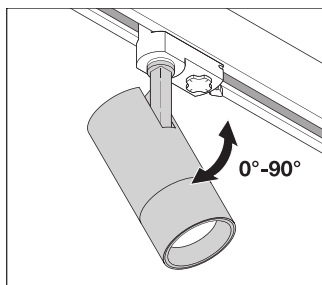
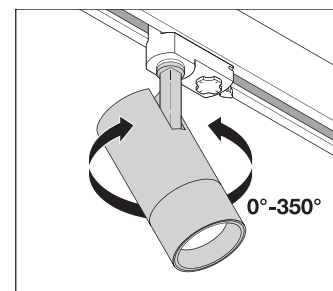
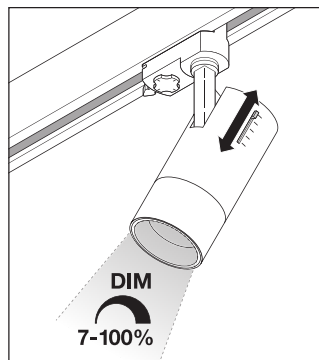
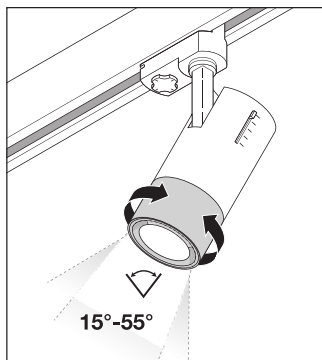

**References / Links**

– For Guarantee see [www.ledvance.com/guarantee](http://www.ledvance.com/guarantee)

---

## DISCLAIMER

Subject to change without notice. Errors and omission excepted. Always make sure to use the most recent release.