



PRODUCT DATASHEET

PANEL VAL 600 36 W 4000 K WT

PANEL VALUE 600 | Square recessed panel luminaires, 600 x 600 mm



Areas of application

- Direct replacement for luminaires with fluorescent lamps
- Offices, conference rooms
- Reception areas, foyers, corridors, elevators
- Suitable for recessed ceiling systems with grid size of 600 x 600 mm

Product benefits

- Value for money luminaire
- Low flicker light thanks to special electronic control gear
- Energy savings thanks to system efficacy of up to 100 lm/W
- External driver for extended flexibility and easy installation
- Versions with DALI ECG available

Product features

- Lifetime (L70/B50) up to 50,000 h (at 25 °C)
- Extruded aluminum frame
- Polystyrene diffuser



TECHNICAL DATA

Electrical data

| | |
|---|---------------------|
| Nominal wattage | 36.00 W |
| Nominal voltage | 220...240 V |
| Mains frequency | 50...60 Hz |
| Nominal current | 170 mA |
| Inrush current | 10.4 A |
| Inrush current time T_{h50} | 200 μ s |
| Max. number of luminaires per miniature circuit breaker B16 | 19 |
| Max. number of luminaires per miniature circuit breaker C10 | 19 |
| Max. number of luminaires per miniature circuit breaker C16 | 30 |
| Power factor λ | > 0.90 |
| Total harmonic distortion | < 15 % |
| Protection class | II |
| Operating mode | External LED driver |

Photometrical data

| | |
|--|--------------------|
| Luminous flux | 3600 lm |
| Luminous efficacy | 100 lm/W |
| Color temperature | 4000 K |
| Light color (designation) | Cool White |
| Color rendering index Ra | > 80 |
| Standard deviation of color matching | 5 sdc _m |
| Luminous intensity | - |
| Low flicker | Yes |
| Flickering metric (Pst LM) | - |
| Stroboscope effect metric (SVM) | - |
| Photobiological safety group acc. to EN62778 | RG0 |
| Beam angle | 120 ° |

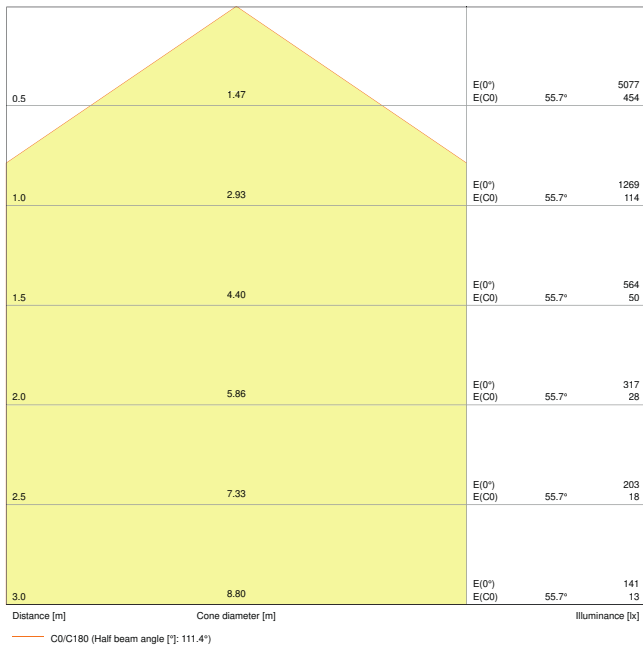

PL VAL 600 36W 4000K

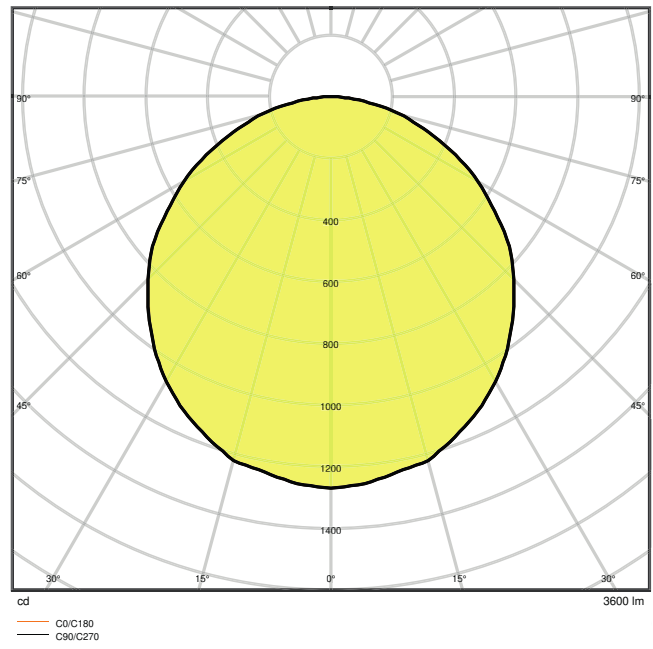

PL VAL 600 36W 4000K

Dimensions & Weight

| | |
|----------------|-----------|
| Length | 595.00 mm |
| Width | 595.00 mm |
| Height | 35.00 mm |
| Product weight | 1800.00 g |

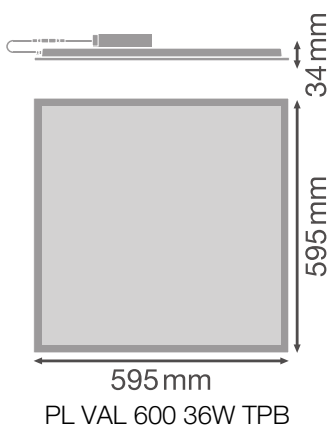

Materials & Colors

| | |
|--|------------------|
| Product color | White |
| Housing color | White |
| Body material | Steel |
| Cover material | Polystyrene (PS) |
| Light emitting surface material | Polystyrene |
| Glow Wire Test according to IEC 60695-2-12 | 650 °C |
| Mercury content | 0.0 mg |

Application & Mounting

| | |
|--|----------------------------|
| Ambient temperature range | -10...+45 °C |
| Type of connection | Screwless terminal |
| Type of protection | IP40 |
| Protection class IK (shock resistance) | IK02 |
| Dimmable | No |
| Mounting type | Recessed/Suspended/Surface |
| Mounting location | Ceiling / Wall |
| Application environment | Indoor |
| Mounting length | 580 mm |
| Mounting width | 580 mm |
| Mounting depth | 50,0 mm |

Lifespan

| | |
|----------------------------|-----------------------|
| Lifespan L70/B50 at 25 °C | 50000 h ¹⁾ |
| Lifespan L80/B10 at 25 °C | 50000 h ¹⁾ |
| Lifespan L80/B50 at 25 °C | 50000 h |
| Lifespan L90/B10 at 25 °C | 30000 h |
| Number of switching cycles | 25000 |

¹⁾ t[h]: L70 / B50 @ 25 °C (Ta), t[h]: L80 / B10 @ 25 °C (Ta), t[h]: L90 / B10 @ 25 °C (Ta)

Control gear

| | |
|-----------------------------|-------|
| ECG - Output ripple current | ≤ 5 % |
|-----------------------------|-------|









Certificates & Standards

| | |
|--|---------------|
| Standards | CE / CB / EAC |
| Luminaire with limited surface temperature, "D sign" | No |
| Ball shot safe | No |

Replaceable light source (EPREL)

Not replaceable

Accessories Optional





| Product image | Product name | EAN |
|---|-------------------------------------|---------------|
|  | PANEL 600 RECESSED MOUNT FRAME | 4058075402881 |
|  | PANEL SECURITY KIT 4x | 4058075472990 |
|  | PANEL Suspension Kit | 4058075402928 |
|  | PANEL 600 SURFACE MOUNT KIT H70 VAL | 4058075402843 |
|  | PANEL 600 SURFACE MOUNT KIT H75 | 4058075472914 |
|  | CONNECTOR BOX 5POLE L/N 4x | 4058075473010 |
|  | PANEL RECESSED MOUNT CLIPS VAL 4x | 4058075409859 |
|  | EM CONVERSION BOX | 4058075237025 |







EQUIPMENT / ACCESSORIES

- Accessories for several mounting options available
- External control gear included

– Security brackets included

DOWNLOAD DATA

| Documents and certificates | | Document name |
|--|--|----------------------------|
|  | User instruction / safety instructions | PL VAL UI |
|  | User instruction / safety instructions | PL VAL 600 625 |
|  | Legal information | LSI PL VAL AND PL VAL DALI |
|  | Legal information | LSI PL VAL AND PL VAL DALI |
|  | Declarations of conformity | PL VAL |

| Photometric and lighting design files | | Document name |
|--|-------------------------------------|----------------------|
|  | IES file (IES) | PL VAL 600 36W 4000K |
|  | LDT file (Eulumdat) | PL VAL 600 36W4000K |
|  | ULD file (DIALux) | PL VAL 600 36W-4000K |
|  | ROLF file (RELUX) | PL VAL 600 |
|  | UGR file (UGR table) | PL VAL 600 36W 4000K |
|  | Light distribution curve type cone | PL VAL 600 36W 4000K |
|  | Light distribution curve type polar | PL VAL 600 36W 4000K |

| Tender texts | Document name |
|--|---|
|  | Tender documents PANEL VALUE 600 36 W 4000 K WT-EN |

LOGISTICAL DATA

| Product code | Packaging unit (Pieces/Unit) | Dimensions (length x width x height) | Gross weight | Volume |
|---------------|------------------------------|--------------------------------------|--------------|-----------------------|
| 4058075392380 | Folding box 1 | 602 mm x 40 mm x 648 mm | 2192.00 g | 15.60 dm ³ |

| Product code | Packaging unit (Pieces/Unit) | Dimensions (length x width x height) | Gross weight | Volume |
|---------------|------------------------------|--------------------------------------|--------------|-----------------------|
| 4058075392397 | Shipping box 4 | 667 mm x 182 mm x 634 mm | 10015.00 g | 76.96 dm ³ |

The mentioned product code describes the smallest quantity unit which can be ordered. One shipping unit can contain one or more single products. When placing an order, for the quantity please enter single or multiples of a shipping unit.

ADDITIONAL CATALOG INFORMATION

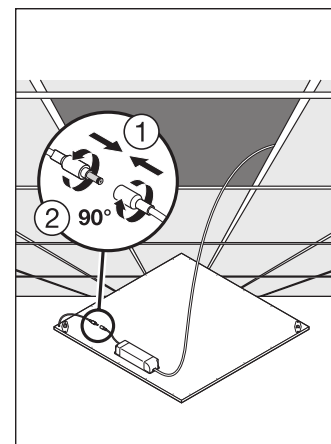
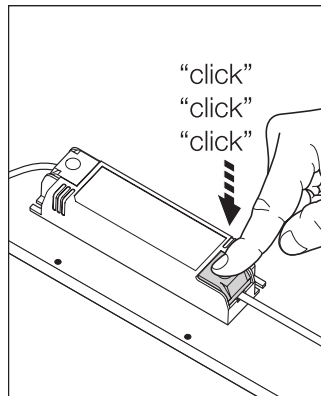
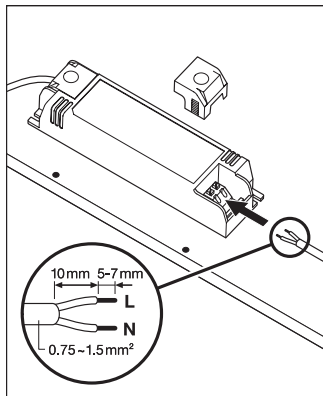

References / Links

– For Guarantee see www.ledvance.com/guarantee

DISCLAIMER

Subject to change without notice. Errors and omission excepted. Always make sure to use the most recent release.