

# PRODUCT DATASHEET

## LN INDV D 1500 48 W 3000 K

LINEAR IndiviLED® DIRECT GEN 1 | Surface mounted luminaire for single luminaire or light line application



---

### Areas of application

- Direct replacement for luminaires with fluorescent lamps
- Offices, schools
- General indoor illumination
- Corridors, entrance areas
- Seamless linear lighting
- Shop lighting



PERFOR-  
MANCE  
CLASS

---

### Product benefits

- Homogenous light distribution and reduced glare thanks to the IndiviLED® optics
- Multiple mounting options
- The product family offers full lighting solution for different applications
- Energy savings of up to 50 % compared to T5 batten luminaires
- Further variants additionally available with DALI ECG, emergency lighting function according to IEC 60598-2-22 or through wiring
- Robust structure with IK06
- Low flicker light thanks to special electronic control gear
- 5 years guarantee

---

### Product features

- Each LED with individual lens and reflector for UGR < 16 and homogenous light distribution
- Pendant mounting with suspension kit



- Linkable into seamless light line with line connection adapter (surface or pendant mounting)
- Available with length of 1200 or 1500 mm
- Luminous flux up to 5700 lm
- Luminous efficacy: up to 125 lm/W
- Initial color consistency: 3 SDCM
- Glow Wire Test according to IEC 60695-2-12: 850 °C
- Versions available with CRI 90
- Luminaire versions with IoT-ready DALI-2 driver or IoT Zigbee 3.0 technology available
- Lifetime (L70/B50): 60,000 h (at 25 °C)

## TECHNICAL DATA

### Electrical data

Nominal wattage	48.00 W
Nominal voltage	220...240 V
Mains frequency	50...60 Hz
Nominal current	280 mA
Inrush current	10 A
Inrush current time $T_{h50}$	200 $\mu$ s
Max. number of luminaires per miniature circuit breaker B16	33
Max. number of luminaires per miniature circuit breaker C10	26
Max. number of luminaires per miniature circuit breaker C16	45
Power factor $\lambda$	> 0.90
Total harmonic distortion	$\leq$ 18 %
Protection class	I
Operating mode	Integrated LED driver

### Photometrical data

Luminous flux	5300 lm
Luminous efficacy	110 lm/W
Color temperature	3000 K
Light color (designation)	Warm White
Color rendering index Ra	$\geq$ 80
Standard deviation of color matching	3 sdcn
Luminous intensity	-
Low flicker	Yes
Flickering metric (Pst LM)	-
Stroboscope effect metric (SVM)	-
Photobiological safety group acc. to EN62778	RG1
Photobiological safety group acc. to EN62471	RG0
Beam angle	70 °
UGR	< 16

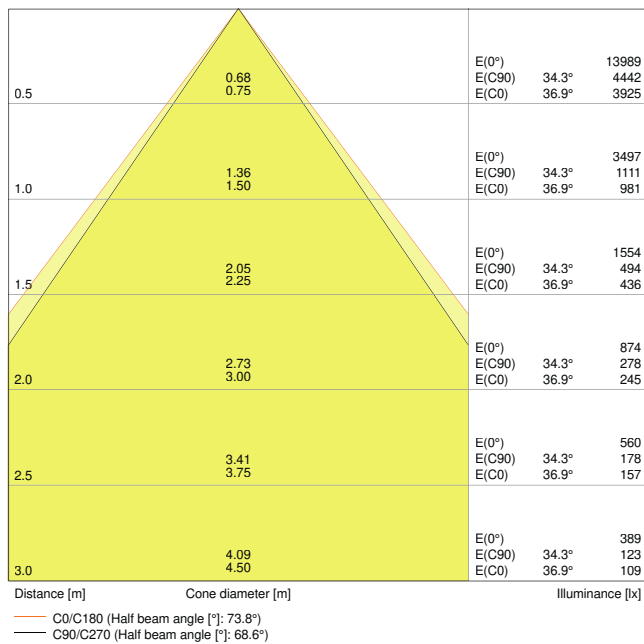

LN INDV D 1500 48W 3000K

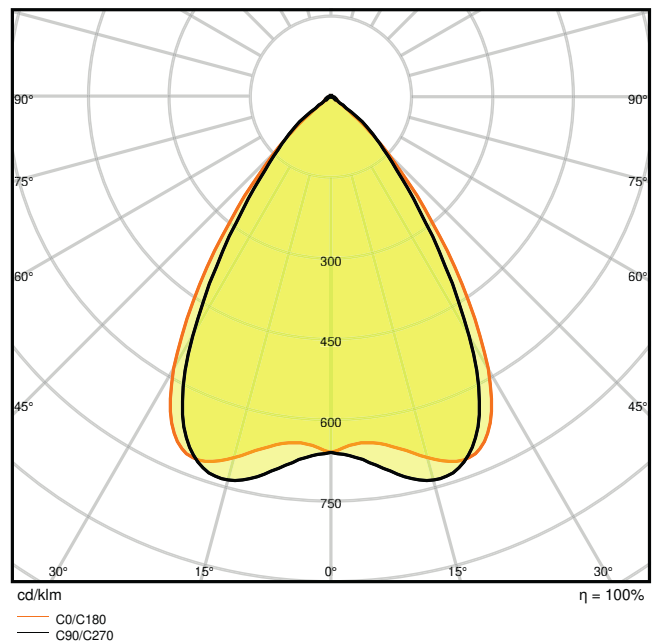

LN INDV D 1500 48W 3000K

Dimensions & Weight

Length	1488.00 mm
Width	120.00 mm
Height	40.00 mm
Product weight	3100.00 g

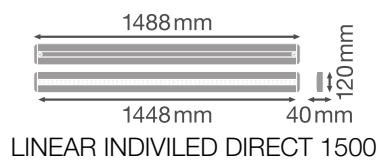

Materials & Colors

Product color	White
Housing color	White
Body material	Aluminum
Cover material	Aluminum
Light emitting surface material	Polycarbonate (PC)

Glow Wire Test according to IEC 60695-2-12	650 °C
Mercury content	0.0 mg

### Application & Mounting

Ambient temperature range	-20...+45 °C
Type of connection	Screwless terminal
Type of protection	IP20
Protection class IK (shock resistance)	IK06
Dimmable	No
Mounting type	Suspended/Surface
Mounting location	Ceiling
Application environment	Indoor
With light source	Yes

### Lifespan

Lifespan L70/B50 at 25 °C	60000 h <sup>1)</sup>
Lifespan L80/B10 at 25 °C	50000 h <sup>1)</sup>
Lifespan L80/B50 at 25 °C	50000 h
Lifespan L90/B10 at 25 °C	35000 h
Number of switching cycles	100000

<sup>1)</sup> t[h]: L70 / B50 @ 25 °C (Ta), t[h]: L80 / B10 @ 25 °C (Ta), t[h]: L90 / B10 @ 25 °C (Ta)

### Certificates & Standards

Standards	CE / CB / TÜV SÜD / EAC
Luminaire with limited surface temperature, "D sign"	No
Ball shot safe	No
Replaceable light source (EPREL)	Not replaceable

### EQUIPMENT / ACCESSORIES















- Ceiling connection box available
- Suspension kit available
- Line connection adapter available
- Through-wiring cable kit available

### Safety advice

- All electrical connections must be made by a qualified person.

- Caution, risk of electric shock.
- Product in protection class I. All electrically conductive, metallic housing parts that can absorb voltage during operation or during maintenance in the event of a fault must be continuously connected to the protective earthing conductor.

**DOWNLOAD DATA**

Documents and certificates		Document name
	User instruction / safety instructions	UI_Linear_IndiviLED
	On-Pack-Info	Legal Insert Linear
	Legal information	LSI LINEAR IndiviLED
	Legal information	Informationstext 18 Abs 4 ElektroG
	Declarations of conformity	CE LN IndiviLED
Photometric and lighting design files		Document name
	IES file (IES)	LN INDV D 1500 48W 3000K
	LDT file (Eulumdat)	LN INDV D 1500 48W 3000K
	ULD file (DIALux)	LINEARIndiviLEDDIRECT150048W3000K
	ROLF file (RELUX)	LN INDV D 1500
	UGR file (UGR table)	LN INDV D 1500 48W 3000K
	Light distribution curve type cone	LN INDV D 1500 48W 3000K
	Light distribution curve type polar	LN INDV D 1500 48W 3000K
CAD/BIM files		Document name
	BIM Revit 3D	Linear IndiviLED G1
	CAD STEP 3D	LN INDV 1500

Tender texts	Document name
 Tender documents	LINEAR IndivLED DIRECT 1500 48 W 3000 K-EN

**LOGISTICAL DATA**

Product code	Packaging unit (Pieces/Unit)	Dimensions (length x width x height)	Gross weight	Volume
4058075109681	Folding box 1	132 mm x 1,624 mm x 52 mm	3342.00 g	11.15 dm <sup>3</sup>
4058075109698	Shipping box 4	1,641 mm x 207 mm x 169 mm	14898.00 g	57.41 dm <sup>3</sup>

The mentioned product code describes the smallest quantity unit which can be ordered. One shipping unit can contain one or more single products. When placing an order, for the quantity please enter single or multiples of a shipping unit.

**ADDITIONAL CATALOG INFORMATION**

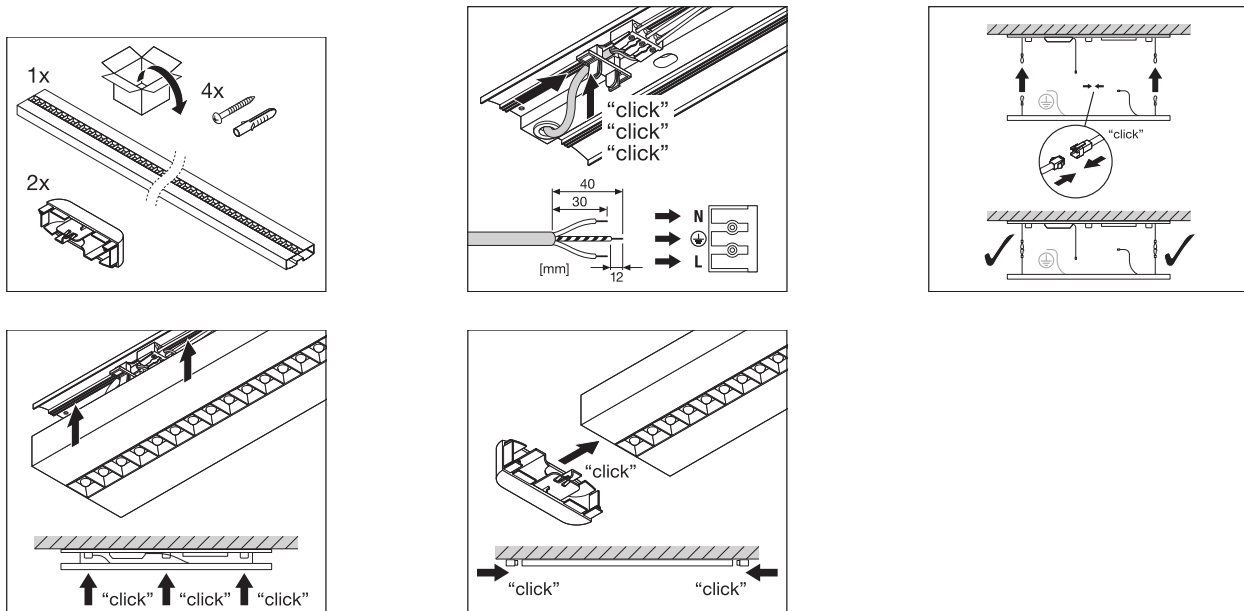

**References / Links**

– For Guarantee see [www.ledvance.com/guarantee](http://www.ledvance.com/guarantee)

**DISCLAIMER**

Subject to change without notice. Errors and omission excepted. Always make sure to use the most recent release.