

PRODUCT DATASHEET

HB 155 W 4000 K 110DEG IP65

HIGH BAY GEN 3 | High-bay luminaires up to 140 lm/W and attractive UGR



PERFOR-
MANCE
CLASS

Areas of application

- Replacement for high bay luminaires with mercury vapor or metal halide lamps
- Warehouses
- Logistics halls
- Industry
- High ceiling (e.g. in shopping malls, airports, commercial buildings, lobbies)

Product benefits

- Improved UGR compared to previous generations, down to $UGR \leq 22$ in combination with reflector
- High luminous efficacy
- Energy savings of up to 60 % compared to conventional high bay luminaires
- 5 years guarantee
- Optimized weight and size due to compact design

Product features

- Different luminous flux and beam angle for mounting heights of ~ 6 m to 14 m in 4000 K or 6500 K



TECHNICAL DATA

Electrical data

Nominal wattage	155.00 W
Nominal voltage	220...240 V
Mains frequency	50...60 Hz
Nominal current	710 mA
Inrush current	49 A
Inrush current time T_{h50}	368 μ s
Max. number of luminaires per miniature circuit breaker B16	5
Max. number of luminaires per miniature circuit breaker C10	5
Max. number of luminaires per miniature circuit breaker C16	8
Power factor λ	> 0.95
Total harmonic distortion	\leq 20 %
Protection class	I
Operating mode	Mains voltage

Photometrical data

Luminous flux	22000 lm
Luminous efficacy	140 lm/W
Color temperature	4000 K
Light color (designation)	Cool White
Color rendering index Ra	\geq 80
Standard deviation of color matching	< 5 sdc _m
Low flicker	Yes
Photobiological safety group acc. to EN62778	RG1
Photobiological safety group acc. to EN62471	RG1
Beam angle	110 °

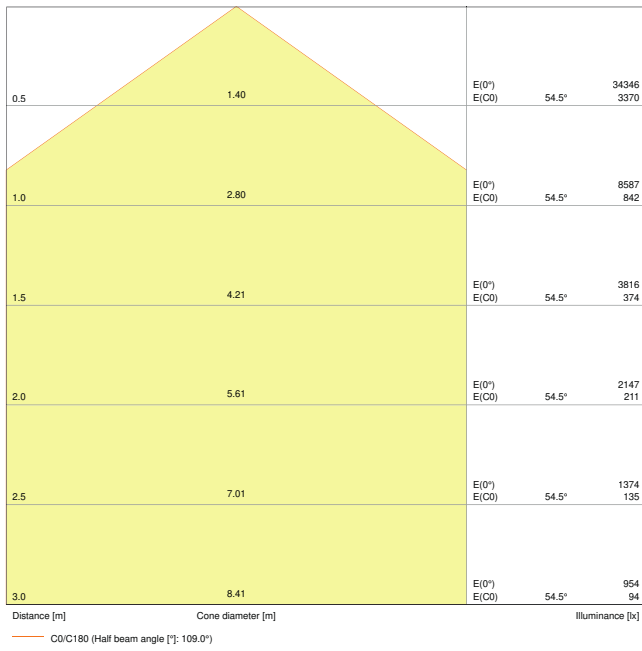

HB PFM 155W4000K 110DEG IP65

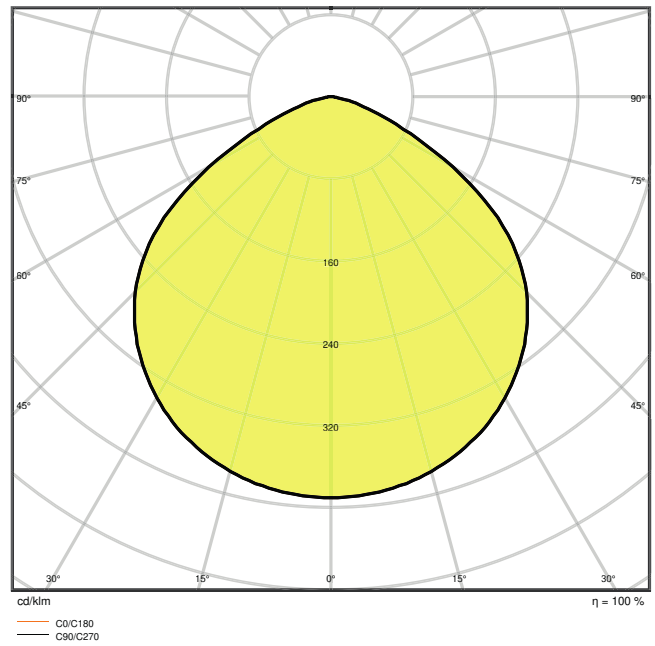

HB PFM 155W4000K 110DEG IP65

Dimensions & Weight

Diameter	321.00 mm
Height	140.00 mm
Product weight	2300.00 g
Cable length	1500 mm

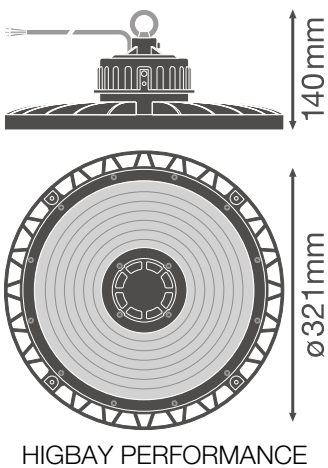

Materials & Colors

Product color	Black
Housing color	Black
Body material	Aluminum
Cover material	Polycarbonate (PC)
Glow Wire Test according to IEC 60695-2-12	850 °C
Mercury content	0.0 mg

Application & Mounting

Ambient temperature range	-30...+55 °C
Temperature range at storage	-40...+70 °C
Type of connection	Cable, 3-pole
Type of protection	IP65
Protection class IK (shock resistance)	IK08
Dimmable	No
Mounting type	Suspended/Surface
Mounting location	Ceiling
Application environment	Indoor
With light source	Yes

Lifespan

Lifespan L70/B50 at 25 °C	80000 h ¹⁾
Lifespan L80/B10 at 25 °C	50000 h ¹⁾
Lifespan L80/B50 at 25 °C	50000 h
Lifespan L90/B10 at 25 °C	35000 h
Number of switching cycles	200000

¹⁾ t[h]: L70 / B50 @ 25 °C (Ta), t[h]: L80 / B10 @ 25 °C (Ta), t[h]: L90 / B10 @ 25 °C (Ta)

Control gear

ECG - Output ripple current	≤ 10 %
-----------------------------	--------





Certificates & Standards





Standards	CE / CB / ENEC / TÜV SÜD / EAC
Luminaire with limited surface temperature, "D sign"	Yes
Replaceable light source (EPREL)	Not replaceable

EQUIPMENT / ACCESSORIES

- Mounting hook included
- Mounting brackets, reflectors and refractors available as separate accessory

DOWNLOAD DATA

Documents and certificates		Document name
	User instruction / safety instructions	HIGHBAY Gen3
	Legal information	LSI_HB_LSR label
	Legal information	Legal insert HB P GEN 4 AND HB GEN 3
	Declarations of conformity	HB

Photometric and lighting design files		Document name
	IES file (IES)	HB 155W4000K 110DEG IP65
	LDT file (Eulumdat)	HB 155W4000K 110DEG IP65
	UGR file (UGR table)	HB 155W4000K 110DEG IP65
	Light distribution curve type cone	HB PFM 155W4000K 110DEG IP65
	Light distribution curve type polar	HB PFM 155W4000K 110DEG IP65

CAD/BIM files		Document name
	BIM Revit 3D	HB GEN3

LOGISTICAL DATA

Product code	Packaging unit (Pieces/Unit)	Dimensions (length x width x height)	Gross weight	Volume
4058075452381	Shipping box 1	377 mm x 377 mm x 177 mm	2940.00 g	25.16 dm ³

The mentioned product code describes the smallest quantity unit which can be ordered. One shipping unit can contain one or more single products. When placing an order, for the quantity please enter single or multiples of a shipping unit.

ADDITIONAL CATALOG INFORMATION

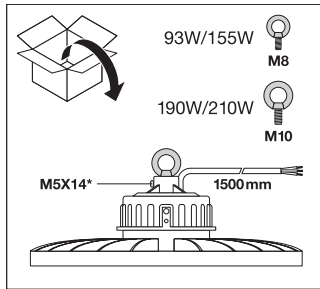

References / Links

– For Guarantee see www.ledvance.com/guarantee

DISCLAIMER

Subject to change without notice. Errors and omission excepted. Always make sure to use the most recent release.