

# PRODUCT DATASHEET

## FL PFM 10 W 6500 K SYM 100 WT

FLOODLIGHT 10 W | Versatile floodlight with up to 1200 lm light output



### Areas of application

- Replacement for floodlights with halogen lamps
- Outdoor use (IP65)
- Public areas
- Building facades
- Construction areas
- Gardens, balconies and other outdoor areas

### Product benefits

- Bright, robust and durable
- Safe and very uniform illumination, due to frosted and tempered glass diffuser
- No upper light output ratio (ULOR 0%) when mounted at 0° tilt
- Energy savings of up to 90 % compared to halogen lamp floodlights
- 5 years guarantee

### Product features

- Reflector-based, symmetric light distribution with 100° x 100° beam angle
- Integrated wide voltage driver, suitable for 100 - 277 V<sub>AC</sub>
- Surge protection: up to 4 kV (L/N-PE), 2 kV (L-N)
- Mounting bracket with 30° angle and wide rotation area
- Pre-installed, flexible 1 m cable (H05RN-F), wrapped 3 x 1.0 mm<sup>2</sup> single wires



## TECHNICAL DATA

### Electrical data

Nominal wattage	10.00 W
Nominal voltage	100...277 V
Mains frequency	50...60 Hz
Nominal current	49 mA
Inrush current	3.68 A
Inrush current time $T_{h50}$	27 $\mu$ s
Max. number of luminaires per miniature circuit breaker B16	195
Max. number of luminaires per miniature circuit breaker C10	142
Max. number of luminaires per miniature circuit breaker C16	228
Power factor $\lambda$	> 0.90
Total harmonic distortion	< 20 %
Protection class	I
Operating mode	Integrated LED driver

### Photometrical data

Luminous flux	1200 lm
Luminous efficacy	120 lm/W
Color temperature	6500 K
Light color (designation)	Cool Daylight
Color rendering index Ra	$\geq$ 80
Standard deviation of color matching	$\leq$ 5 sdc <sub>m</sub>
Luminous intensity	-
Flickering metric (Pst LM)	-
Stroboscope effect metric (SVM)	-
Photobiological safety group acc. to EN62778	RG1
Photobiological safety group acc. to EN62471	RG1
Beam angle	100 ° x 100 °

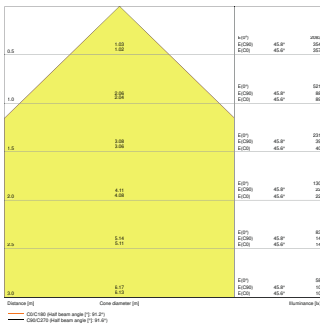

FL PFM 10W6500K SYM 100 WT

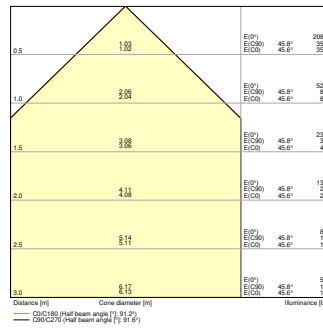

FL PFM 10W 6500K SYM 100 WT

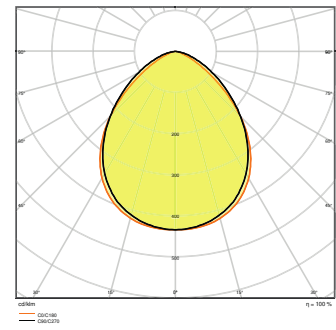

FL PFM 10W6500K SYM 100 WT

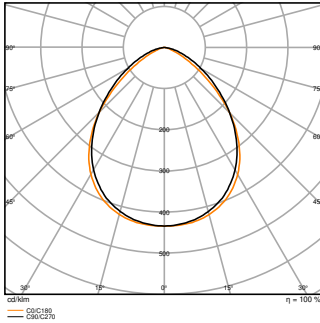

FL PFM 10W 6500K SYM 100 WT

Dimensions & Weight

Length	122.00 mm
Width	131.00 mm
Height	36.00 mm
Product weight	400.00 g
Cable length	1000 mm

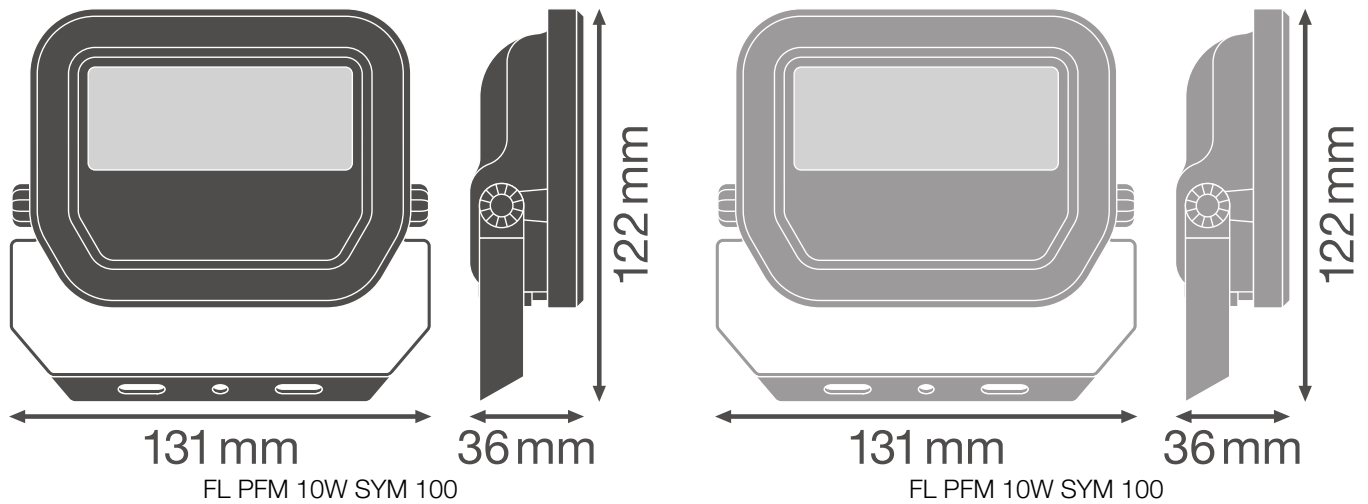

**Materials & Colors**

Product color	White
Housing color	White
Body material	Aluminum
Light emitting surface material	Glass
Glow Wire Test according to IEC 60695-2-12	650 °C
Mercury content	0.0 mg

**Application & Mounting**

Ambient temperature range	-30...+50 °C
Temperature range at storage	-40...+70 °C
Type of connection	Cable, 3-pole
Type of protection	IP65
Protection class IK (shock resistance)	IK07
Dimmable	No
Mounting type	Surface
Mounting location	Wall / Ceiling / Floor
Application environment	Outdoor
Adjustable	Yes
With light source	Yes

**Lifespan**

Lifespan L70/B50 at 25 °C	70000 h <sup>1)</sup>
Lifespan L80/B10 at 25 °C	55000 h <sup>1)</sup>
Lifespan L80/B50 at 25 °C	55000 h
Lifespan L90/B10 at 25 °C	35000 h
Number of switching cycles	100000

1) t[h]: L70 / B50 @ 25 °C (Ta), t[h]: L80 / B10 @ 25 °C (Ta), t[h]: L90 / B10 @ 25 °C (Ta)

### Control gear

Output current	220 mA
ECG - Output ripple current	< 50 %





### Certificates & Standards





Standards	CE / CB / ENEC / EAC / RoHS / EPD
Luminaire with limited surface temperature, "D sign"	No
Ball shot safe	No
EPD	LEDV-00009-V01.01-EN
Replaceable light source (EPREL)	Not replaceable













### Safety advice

- All electrical connections must be made by a qualified person.
- The external flexible cable or cord of this luminaire cannot be replaced; if the cord is damaged, the luminaire shall be destroyed.
- Terminal block not included. Installation must be made by a qualified person.
- Caution, risk of electric shock.
- Product in protection class I. All electrically conductive, metallic housing parts that can absorb voltage during operation or during maintenance in the event of a fault must be continuously connected to the protective earthing conductor.

### DOWNLOAD DATA

	Documents and certificates	Document name
	User instruction / safety instructions	FL PFM SYM
	Legal information	FL PFM SYM
	Legal information	LSI FL PFM SYM
	Legal information	LSI FL PFM SYM

Documents and certificates		Document name
	Legal information	FL PFM SYM
	Legal information	Informationstext 18 Abs 4 ElektroG
	Declarations of conformity	FL PFM
	Declarations of conformity UKCA	FL PFM SYM
	Declarations of conformity UKCA	FL PFM

Photometric and lighting design files		Document name
	IES file (IES)	FL PFM 10W6500K SYM 100 WT
	IES file (IES)	FL PFM 10W 6500K SYM 100 WT
	LDT file (Eulumdat)	FL PFM 10W6500K SYM 100 WT
	LDT file (Eulumdat)	FL PFM 10W 6500K SYM 100 WT
	ULD file (DIALux)	FL PFM 10W-6500K SYM 100 WT
	ROLF file (RELUX)	FL PFM 10W-6500K SYM
	UGR file (UGR table)	FL PFM 10W6500K SYM 100 WT
	UGR file (UGR table)	FL PFM 10W 6500K SYM 100 WT
	Light distribution curve type cone	FL PFM 10W6500K SYM 100 WT
	Light distribution curve type cone	FL PFM 10W 6500K SYM 100 WT
	Light distribution curve type polar	FL PFM 10W6500K SYM 100 WT
	Light distribution curve type polar	FL PFM 10W 6500K SYM 100 WT

CAD/BIM files		Document name
	BIM Revit 3D	Floodlight G3

CAD/BIM files		Document name
	CAD STEP 3D	FL G3 10W

---

Tender texts		Document name
	Tender documents	FLOODLIGHT 10 W 6500 K SYM 100 WT-EN

**LOGISTICAL DATA**

Product code	Packaging unit (Pieces/Unit)	Dimensions (length x width x height)	Gross weight	Volume
4058075420946	Folding box 1	136 mm x 57 mm x 118 mm	447.00 g	0.91 dm <sup>3</sup>
4058075420953	Shipping box 12	360 mm x 286 mm x 144 mm	5840.00 g	14.83 dm <sup>3</sup>

The mentioned product code describes the smallest quantity unit which can be ordered. One shipping unit can contain one or more single products. When placing an order, for the quantity please enter single or multiples of a shipping unit.

**ADDITIONAL CATALOG INFORMATION**

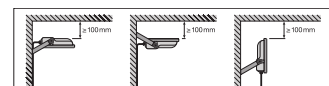
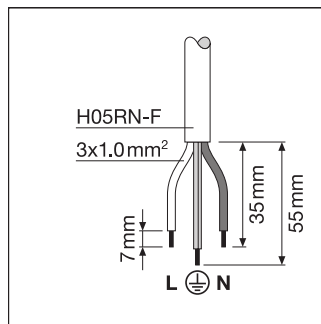
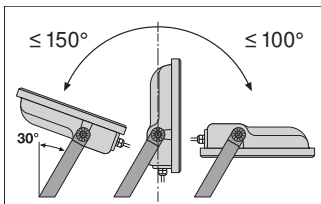

**References / Links**

– For Guarantee see [www.ledvance.com/guarantee](http://www.ledvance.com/guarantee)

**DISCLAIMER**

Subject to change without notice. Errors and omission excepted. Always make sure to use the most recent release.